



OmegaEE XD
MI 3365 (25A, M, F)
Instruction manual
Ver. 1.5.6, Code no. 20 753 338

Distributor:

Manufacturer:

Metrel d.o.o.
Ljubljanska cesta 77
SI-1354 Horjul
[e-mail:info@metrel.si](mailto:info@metrel.si)
<https://www.metrel.si>

DATA BACKUP AND LOSS:

It is the user's responsibility to ensure the integrity and security of the data carrier and to regularly backup and validate the integrity of backups of the data. METREL HAS NO OBLIGATION OR LIABILITY FOR ANY LOSS, ALTERATION, DESTRUCTION, DAMAGE, CORRUPTION OR RECOVERY OF USER DATA, REGARDLESS OF WHERE THE DATA IS STORED.



Mark on your equipment certifies that it meets requirements of all subjected EU regulations.



Hereby, Metrel d.o.o. declares that the MI 3365, MI 3365 25A, MI 3365 M, and MI 3365 F are in compliance with Directive 2014/53/EU (RED) and all other subjected EU directive. The full text of the EU declaration of conformity is available at the following internet address <https://www.metrel.si/DoC>.



Mark on your equipment certifies that it meets requirements of all subjected UK regulations.



Hereby, Metrel d.o.o. declares that the MI 3365, MI 3365 25A, MI 3365 M, and MI 3365 F are in compliance with Radio Equipment Regulations 2017 and all other subjected UK regulations. The full text of the UK declaration of conformity is available at the following internet address <https://www.metrel.si/UK-DoC>.

© Metrel d.o.o.

Published: 06/2025

The trade names Metrel®, Smartec®, Eurotest®, Auto Sequence® are trademarks registered in Europe and other countries.

No part of this publication may be reproduced or utilized in any form or by any means without permission in writing from METREL.

i. About the instruction manual

- ▶ This Instruction manual contains detailed information on the OmegaEE XD, its key features, functionalities and use.
- ▶ It is intended for technically qualified personnel responsible for the product and its use.
- ▶ Please note that LCD screenshots in this document may differ from the actual instrument screens in details due to firmware variations and modifications.
- ▶ *Metrel* reserve the right to make technical modifications without notice as part of the further development of the product.

TABLE OF CONTENTS

1	General description.....	10
1.1	Warnings and notes	10
1.1.1	<i>Safety warnings</i>	10
1.1.2	<i>Warnings related to safety of measurement functions</i>	11
1.1.2.1	Flash HV	11
1.1.2.2	Differential leak., Ipe leak., Touch leak., Ileak (W-PE), Protective conductor current, Power, Leak's & Power, Equipment leak., Applied part leak., Ipe+Ifi, Itou+Ifi, Touch current, Patient Leakage	11
1.1.2.3	Insulation resistance.....	11
1.1.3	<i>Markings on the instrument</i>	11
1.2	Power management	12
1.2.1	<i>230 V / 110 V operation</i>	12
1.2.2	<i>Battery and charging, auto power off</i>	12
1.2.3	<i>Power Off, Restart</i>	13
1.3	Standards applied	13
2	OmegaEE XD Instrument set and accessories	15
2.1	Standard set of the instrument MI 3365, MI 3365 M, MI 3365 25A	15
2.2	Standard set of the instrument MI 3365 F	15
2.3	Optional accessories.....	15
3	Instrument description	16
3.1	Front panel	16
4	Instrument operation	18
4.1	General meaning of keys	18
4.2	General meaning of touch gestures	18
4.3	Virtual keyboard	19
4.4	Safety checks.....	19
4.5	Symbols and messages.....	20
4.6	Fuse checker	24
4.7	Instrument main menu	24
4.8	General settings	26
4.8.1	<i>Language</i>	27
4.8.2	<i>Date and time</i>	27
4.8.3	<i>Profiles</i>	27
4.8.4	<i>Workspace Manager</i>	27
4.8.5	<i>Auto Sequence® groups</i>	27
4.8.6	<i>Settings</i>	28
4.8.7	<i>Bluetooth initialization</i>	30
4.8.8	<i>Initial Settings</i>	30
4.8.9	<i>About</i>	30
4.8.10	<i>User Accounts</i>	31

4.8.10.1	Signing in.....	31
4.8.10.2	Changing user password, signing out	32
4.8.10.3	Managing accounts	33
4.8.11	Setting user permissions	35
4.8.12	Setting Black-box password.....	35
4.9	Connectivity.....	36
4.10	Devices.....	36
4.11	Instrument profiles	37
4.12	Workspace Manager	38
4.12.1	Workspaces and Exports	38
4.12.2	Workspace Manager main menu	38
4.12.2.1	Operations with Workspaces.....	39
4.12.2.2	Operations with Exports	40
4.12.2.3	Adding a new Workspace.....	41
4.12.2.4	Opening a Workspace	41
4.12.2.5	Deleting a Workspace / Export	42
4.12.2.6	Importing a Workspace.....	42
4.12.2.7	Exporting a Workspace	43
4.13	Auto Sequence® groups	44
4.13.1	Auto Sequence® groups menu.....	44
4.13.1.1	Operations in Auto Sequence® groups menu.....	45
4.13.1.2	Selecting a list of Auto Sequences®	45
4.13.1.3	Deleting a list of Auto Sequences®.....	46
5	Memory Organizer	47
5.1	Memory Organizer menu.....	47
5.1.1	Measurement statuses.....	47
5.1.2	Structure Objects.....	48
5.1.2.1	Measurement status indication under the Structure object	49
5.1.3	Selecting an active Workspace in Memory Organizer	50
5.1.4	Adding Nodes in Memory Organizer.....	50
5.1.5	Operations in Tree Menu	51
5.1.5.1	Operations on measurements (finished or empty measurements)	51
5.1.5.2	Operations on Structure objects.....	53
5.1.5.3	View / Edit parameters and attachments of a Structure object	54
5.1.5.4	Add a new Structure Object	56
5.1.5.5	Add a new measurement.....	58
5.1.5.6	Clone a Structure object.....	60
5.1.5.7	Clone a measurement	61
5.1.5.8	Copy & Paste a Structure object	62
5.1.5.9	Copy & Paste a measurement.....	63
5.1.5.10	Cut & Paste a Structure object with sub-items.....	64
5.1.5.11	Delete a Structure object	65
5.1.5.12	Delete a measurement	66
5.1.5.13	Rename a Structure object	66
5.1.5.14	Recall and Retest selected measurement	67

5.1.6	Searching in Memory Organizer	68
6	Single tests.....	71
6.1	Selection modes	71
6.1.1	Single test screens.....	72
6.1.1.1	Single test start screen	73
6.1.1.2	Setting parameters and limits of single tests	73
6.1.1.3	Single test screen during test	74
6.1.1.4	Single test result screen	75
6.1.1.5	Single test memory screen	76
6.1.2	Single test (inspection) screens.....	77
6.1.2.1	Single test (inspection) start screen.....	77
6.1.2.2	Single test (Inspection) screen during test	78
6.1.2.3	Single test (Inspection) result screen.....	79
6.1.2.4	Single test (inspection) memory screen.....	80
6.1.3	Help screens.....	81
6.2	Single test measurements.....	82
6.2.1	Visual inspection	82
6.2.2	Continuity // Protective earth resistance.....	82
6.2.2.1	Compensation of test lead(s) / IEC test cable resistance.....	83
6.2.2.2	Limit calculator	85
6.2.3	Flash test.....	87
6.2.4	Insulation resistance (Riso, Riso-S)	88
6.2.5	Sub-leakage (Isub, Isub-S)	89
6.2.6	Differential Leakage.....	90
6.2.7	Ipe Leakage.....	91
6.2.8	Touch Leakage.....	92
6.2.9	Itouch+Ifloating input.....	94
6.2.10	Ipe+Ifloating input.....	96
6.2.11	Power.....	98
6.2.12	Leak's & Power	99
6.2.13	PRCD test.....	101
6.2.14	RCD test.....	102
6.2.15	PE conductor (PRCD).....	103
6.2.16	Open conductor (PRCD).....	104
6.2.17	PRCD PE probe test.....	105
6.2.18	Polarity.....	106
6.2.19	Clamp current	107
6.2.20	Insulation resistance – Riso (welding equipment).....	108
6.2.21	Welding Circuit Leakage – I leak (W-PE).....	108
6.2.22	Protective conductor current	109
6.2.23	No-load voltage.....	110
6.2.24	Insulation resistance – Riso (medical equipment).....	110
6.2.25	Equipment Leakage.....	112
6.2.26	Applied Part Leakage	114
6.2.27	Touch Current (medical equipment).....	116

6.2.28	<i>Patient Leakage Current</i>	117
6.2.29	<i>SELV/PELV Voltage</i>	118
6.2.30	<i>EVSE Diagnostic Test (A 1632)</i>	120
6.2.31	<i>EV-RCD</i>	121
6.2.32	<i>PE conductor (EV RCD)</i>	123
6.2.32.1	<i>Compensation of IEC plug adapter resistance</i>	123
6.2.33	<i>Functional test</i>	125
7	Auto Sequences®	126
7.1	Selection of Auto Sequences®	126
7.1.1	<i>Selecting an active Auto Sequence® group in Auto Sequences® menu</i>	126
7.1.2	<i>Searching in Auto Sequences® menu</i>	127
7.1.3	<i>Organization of Auto Sequences® in Auto Sequences® menu</i>	129
7.2	Organization of an Auto Sequence®	130
7.2.1	<i>Auto Sequence® view menu</i>	130
7.2.1.1	<i>Auto Sequence® view menu (Header is selected)</i>	130
7.2.1.2	<i>Auto Sequence® view menu (measurement is selected)</i>	131
7.2.1.3	<i>Auto Sequence® Configurator menu</i>	132
7.2.1.4	<i>Indication of Loops</i>	133
7.2.1.5	<i>Managing multiple points</i>	133
7.2.2	<i>Step by step execution of Auto Sequences®</i>	133
7.2.3	<i>Auto Sequence® result screen</i>	135
7.2.4	<i>Auto Sequence® memory screen</i>	137
8	Maintenance	139
8.1	Periodic calibration	139
8.2	Fuses.....	139
8.3	Service.....	139
8.4	Cleaning	139
9	Communications	140
9.1	USB and RS232 communication with PC	140
9.2	Bluetooth communication	140
9.3	Bluetooth communication with printers and scanners	141
9.4	RS232 communication with other external devices	141
9.5	Connections to test adapters.....	142
9.5.1	<i>Active 3 Phase Adapter /Plus (A 1322 / A 1422)</i>	142
9.5.2	<i>3-phase Active Leakage Adapter (A 1830)</i>	142
9.5.3	<i>110 V Test Adapter (A 1474)</i>	143
9.5.4	<i>Tip Commander (A 1694)</i>	143
10	Technical specifications	144
10.1	Continuity // Protective earth resistance.....	144
10.2	Insulation Resistance (Riso, Riso-S)	144
10.3	Sub-Leakage (Isub, Isub-S).....	145
10.4	Differential Leakage	145
10.5	Touch Leakage.....	146

10.6	Ipe Leakage.....	146
10.7	Ipe+Ifloating input (Ipe+Ifi)	147
10.8	Itouch+Ifloating input (Itou+Ifi)	148
10.9	Power	149
10.10	Leak's & Power	150
10.11	PRCD test.....	152
10.12	RCD test.....	153
10.13	PE conductor (PRCD)	153
10.14	Open conductor (PRCD).....	154
10.15	PRCD PE probe test	154
10.16	EV RCD test	155
10.17	EVSE Diagnostic test (A 1632).....	155
10.18	PE conductor (EV RCD)	155
10.19	Polarity.....	156
10.20	Clamp current	156
10.21	Flash test.....	157
10.22	Insulation resistance Riso (welding equipment).....	157
10.23	Welding Circuit leakage (Ileak W-PE)	158
10.24	Protective Conductor current (I diff)	158
10.25	No-load voltage	158
10.26	Insulation Resistance Riso (medical equipment)	158
10.27	Equipment Leakage	158
10.28	Applied Part Leakage	159
10.29	Touch Current (medical equipment)	160
10.30	Patient Leakage.....	160
10.31	SELV/PELV Voltage	161
10.32	Fuse checker	162
10.33	General data	162
Appendix A	Structure objects in OmegaEE XD	164
Appendix B	Profile Notes	165
Appendix C	Print labels and write / read RFID / NFC tags.....	166
C.1	PAT tag format	166
C.2	Generic tag format.....	168
Appendix D	Default list of Auto Sequences®	170
Appendix E	Programming of Auto Sequences® on Metrel ES Manager.....	171
E.1	Auto Sequence® Editor workspace	171
E.2	Managing groups of Auto Sequences®	172
E.2.1	<i>Auto Sequence® Name, Description and Image editing</i>	174
E.2.2	<i>Search within selected Auto Sequence® group</i>	175
E.3	Elements of an Auto Sequence®	175
E.3.1	<i>Auto Sequence® steps</i>	175
E.3.2	<i>Single tests</i>	176
E.3.3	<i>Flow commands</i>	176

E.3.4	Number of measurement steps.....	176
E.4	Creating / modifying an Auto Sequence®	176
E.5	Description of flow commands	177
E.6	Custom Inspections programming.....	180
E.6.1	Creating and editing Custom Inspections	180
E.6.2	Applying Custom Inspections.....	182
Appendix F	Testing in IT or CT supply systems.....	184
Appendix G	User permissions.....	185
G.1	Standard	185
G.2	Instructed	185
Appendix H	OmegaEE XD models and available measuring functions.....	187

1 General description

1.1 Warnings and notes

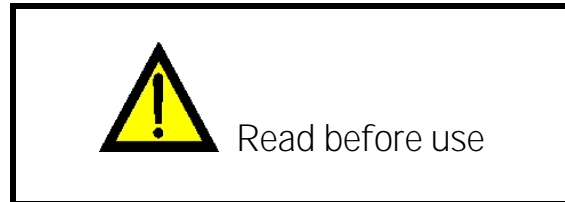

1.1.1 Safety warnings

In order to reach high level of operator safety while carrying out various measurements using the OmegaEE XD instrument, as well as to keep the test equipment undamaged, it is necessary to consider the following general warnings:

- Read this user manual carefully, otherwise use of the instrument may be dangerous for the operator, for the instrument or for the equipment under test!
- Consider warning markings on the instrument!
- If the test equipment is used in manner not specified in this user manual the protection provided by the equipment may be impaired!
- Do not use the instrument and accessories if any damage is noticed!
- Regularly check the instrument and accessories for correct functioning to avoid hazard that could occur from misleading results.
- Consider all generally known precautions in order to avoid risk of electric shock while dealing with hazardous voltages!
- Use only standard or optional test accessories supplied by your distributor!
- Only test equipment provided or approved by Metrel should be connected to 3-PHASE ADAPTER connector.
- Do not connect external voltage to CLAMP inputs. It is intended only for connection of Clamps approved by Metrel.
- Use only earthed mains outlets to supply the instrument!
- Do not switch mains supply between 110 V and 230 V instantly, otherwise the instrument could get damaged. At least 3 s delay, with instrument turned off, should be used between mains voltage system switching.
- If working on other than 230 V TN/TT voltage systems refer to chapter *1.2.1 230 V / 110 V operation*.
- In case a fuse has blown refer to chapter *8.2 Fuses* to replace it!

- Calibration, adjustment and repairing of the instrument is allowed to be carried out only by a competent authorized person!
- Metrel Auto Sequences® are designed as guidance to tests in order to significantly reduce testing time, improve work scope and increase traceability of the tests performed. METREL assumes no responsibility for any Auto Sequence® by any means. **It is the user's responsibility, to** check adequacy for the purpose of use of the selected Auto Sequence®. This includes type and number of tests, sequence flow, test parameters and limits.

1.1.2 Warnings related to safety of measurement functions

1.1.2.1 Flash HV

- A voltage of up to 3 kV_{AC} between FLASH and mains socket LN terminals / 1.5 kV_{AC} between **main socket's** LN and PE socket terminals / 1.5 kV_{AC} between FLASH and mains socket PE terminal **is applied to the instrument's outputs during the test. Although** the current of the HV source is limited to safe level special safety consideration must be taken when performing this test!

1.1.2.2 Differential leak., Ipe leak., Touch leak., Ileak (W-PE), Protective conductor current, **Power, Leak's & Power**, Equipment leak., Applied part leak., Ipe+Ifi, Itou+Ifi, Touch current, Patient Leakage





- Load current higher than 10 A can result in high temperatures of fuse holders! It is advisable not to run tested devices with load currents above 10 A for more than 15 minutes. Recovery period for cooling is required before proceeding with tests! Maximum intermittent duty cycle for measurements with load currents higher than 10 A is 50 %.

1.1.2.3 Insulation resistance

- Do not touch the test object during the measurement or before it is fully discharged! Risk of electric shock!

1.1.3 Markings on the instrument

-  Read the Instruction manual with special care to safety operation«. The symbol requires an action!

- ▶  Dangerous high voltage is present on terminals during the test. Consider all precautions in order to avoid risk of electric shock.
- ▶  Mark on your equipment certifies that this equipment meets requirements of all subjected EU regulations.
- ▶  Mark on your equipment certifies that this equipment meets requirements of all subjected UK regulations.
- ▶  This equipment should be recycled as electronic waste.

1.2 Power management

1.2.1 230 V / 110 V operation

The instrument works on 110 V and 230 V mains. 110 V and 230 V appliances can be fully tested, except if testing appliances in IT or CT supply system; see *Appendix F* for limitations.

In UK and Aus/Nz models only 110 V mains voltage will be applied to the mains test socket if the 110 V test adapter (A 1474) is connected to the instrument.

1.2.2 Battery and charging, auto power off

The instrument has an in-built rechargeable battery pack. The battery is charged whenever the instrument is connected to the mains. When the instrument is disconnected from mains, the battery provides power to the instrument to stay energized for 5 minutes. This is indicated by the battery symbol in the upper right corner of the LCD. Operation with the instrument is not possible except the mains was disconnected during the RCD test. As long as the instrument is energized it will be ready to use immediately after connected to mains voltage again. This enables faster testing of appliances.

If the instrument is not reconnected to mains within 5 minutes it will completely switch off. When connected to mains again, a normal power up procedure will be taken.

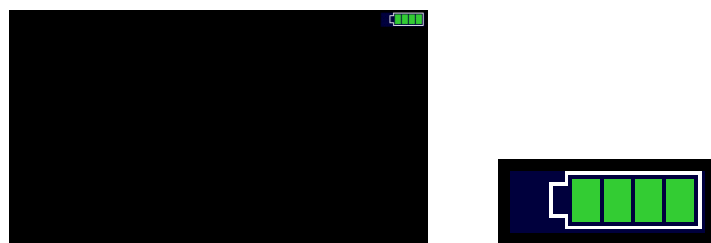

Figure 1.1: Indication of battery status

Notes:

- A flat or faulty battery will result in an immediate power off after the instrument is disconnected from the mains.
- Charging time of the battery is about 14 h.

1.2.3 Power Off, Restart

Instrument is powered by battery:

- when pressing the ESC key for ca 10 s the instrument will switch off.

Instrument is connected to mains:

- when pressing the ESC key for ca 10 s the instrument will restart.

1.3 Standards applied

The OmegaEE XD instrument is manufactured and tested according to the following regulations, listed below.

Electromagnetic compatibility (EMC)

EN 61326-1	Electrical equipment for measurement, control and laboratory use - EMC requirements – Part 1: General requirements
------------	--

Safety (LVD)

EN 61010-1	Safety requirements for electrical equipment for measurement, control, and laboratory use – Part 1: General requirements
EN 61010-2-030	Safety requirements for electrical equipment for measurement, control and laboratory use – Part 2-030: Particular requirements for testing and measuring circuits
EN 61010-031	Safety requirements for electrical equipment for measurement, control and laboratory use – Part 031: Safety requirements for hand-held probe assemblies for electrical measurement and test
EN 61010-2-032	Safety requirements for electrical equipment for measurement, control and laboratory use – Part 2-032: Particular requirements for hand-held and hand-manipulated current sensors for electrical test and measurement
EN 61557	Electrical safety in low voltage distribution systems up to 1 000 V a.c. and 1 500 V d.c. – Equipment for testing, measuring or monitoring of protective measures Instrument complies with all relevant parts of EN 61557 standards.

Functionality

Code of Practice	Household and similar electrical appliances
EN 50699 (VDE 0702)	Recurrent Test of Electrical Equipment
EN 50678 (VDE 0701)	General procedure for verifying the effectiveness of the protective measures of electrical equipment after repair
IEC/EN 62368-1	Audio/video, information and communication technology equipment - Part 1: Safety requirements
IEC/EN 60974-4	Arc welding equipment - Part 4: Periodic inspection and testing
IEC/EN 62353	Medical electrical equipment - Recurrent test and test after repair of medical electrical equipment
AS/NZS 3760	In-service safety inspection and testing of electrical equipment
NEN 3140	Operation of electrical installations - Low voltage
IEC/EN 62752	In-cable control and protection device for mode 2 charging of electric road vehicles (IC-CPD)
EN 61851-1	Electric vehicle conductive charging system - Part 1: General requirements

2 OmegaEE XD Instrument set and accessories

2.1 **Standard set of the instrument MI 3365, MI 3365 M, MI 3365 25A**

- ▶ Instrument MI 3365 /25A /M - OmegaEE XD
- ▶ Bag for accessories
- ▶ Alligator clip (black)
- ▶ Test tip (black)
- ▶ Test lead (black)
- ▶ IEC test cable 3 x 1.5 mm², 2 m
- ▶ Mains cable, 3 x 1.5 mm², 2 m
- ▶ USB cable
- ▶ Calibration Certificate
- ▶ Short form instruction manual (Quick Guide)
- ▶ SW 1201 Metrel ES Manager*

2.2 **Standard set of the instrument MI 3365 F**

- ▶ Instrument MI 3365 F - OmegaEE XD
- ▶ Bag for accessories
- ▶ Flash test probe
- ▶ Alligator clip (red)
- ▶ Alligator clip (black)
- ▶ Test tip (black)
- ▶ Test lead (black)
- ▶ IEC test cable 3 x 1.5 mm², 2 m
- ▶ Mains cable, 3 x 1.5 mm², 2 m
- ▶ USB cable
- ▶ Calibration Certificate
- ▶ Short form instruction manual (Quick Guide)
- ▶ SW 1201 Metrel ES Manager*

*SW 1201 Metrel ES Manager and all documentation can be downloaded free of charge from Metrel Web server (<https://www.metrel.si/en/downloads/>) or Metrel Documentation center (<https://doc.metrel.si/>).

2.3 **Optional accessories**

See the attached sheet for a list of optional accessories that are available on request from your distributor.

3 Instrument description

3.1 Front panel

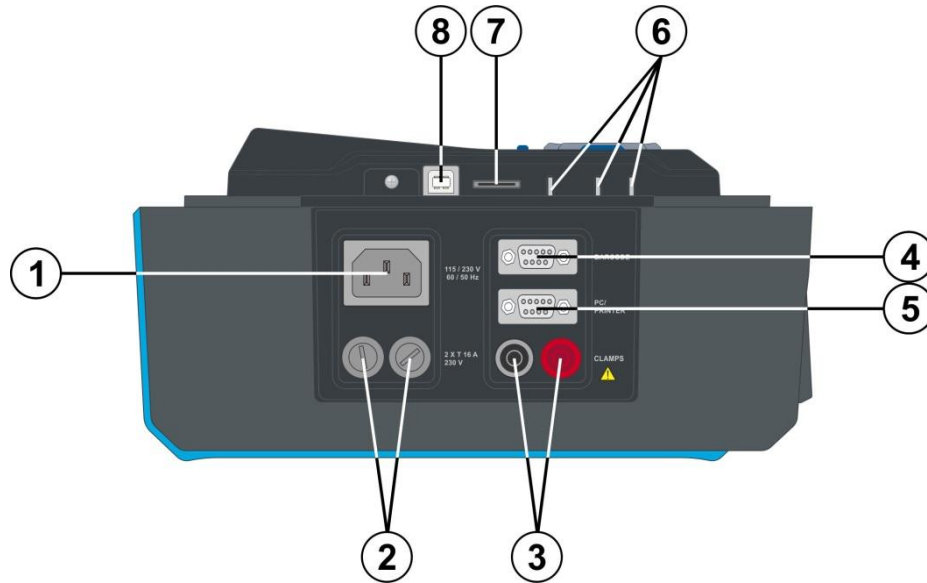

Figure 3.1: Left side panel

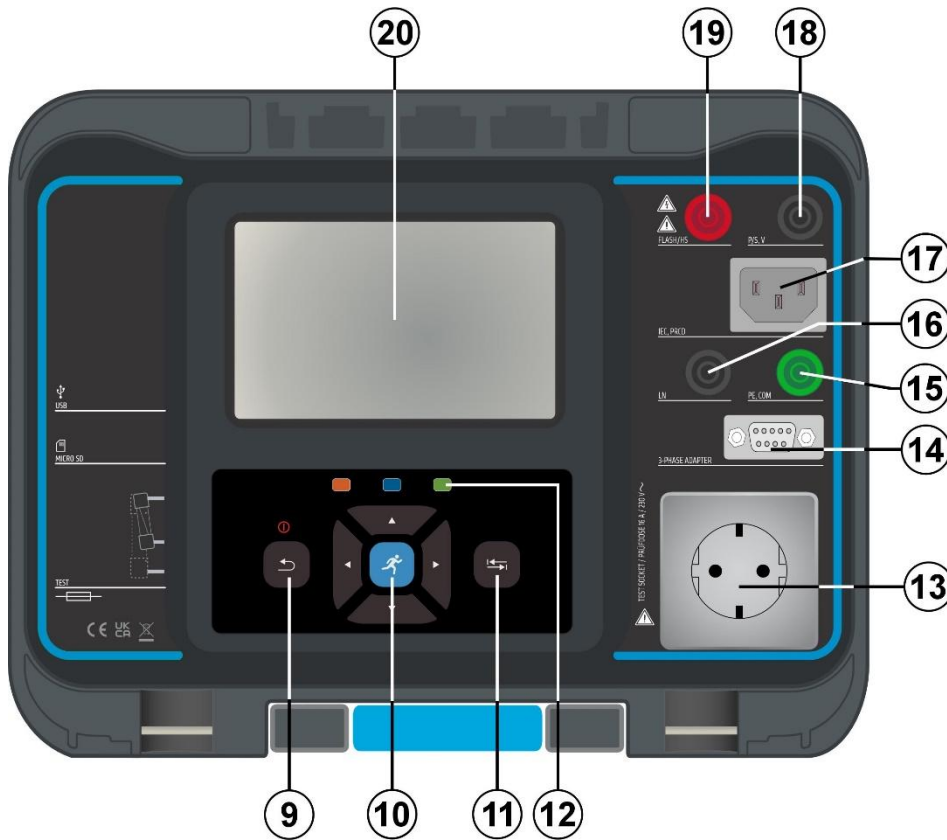

Figure 3.2: Front panel

1	Mains supply connector
---	------------------------

2	F1, F2 fuses (T 16 A / 250 V)
3	Clamp inputs
4	Barcode scanner and RFID / NFC reader / writer device serial port
5	PC / Printer serial port
6	Fuse checker
7	MicroSD card slot
8	USB communication port
9	Escape key / reset key
10	Keypad
11	TAB key
12	Shortcut keys
13	Mains test socket
14	Data connection 3 phase adapter
15	PE, COM connector
16	LN connector
17	IEC, PRCD test connector
18	P/S, V (probe) connector, P/AP, V (probe / applied part) connector
19	FLASH/HS output connector
20	Colour TFT display with touch screen

4 Instrument operation

The instrument can be manipulated via a keypad or touch screen.

4.1 General meaning of keys

	<p>Cursor keys are used to:</p> <ul style="list-style-type: none"> - select appropriate option.
	<p>RUN key is used to:</p> <ul style="list-style-type: none"> - confirm selected option, - start and stop measurements.
	<p>Escape key is used to:</p> <ul style="list-style-type: none"> - return to previous menu without changes, - abort measurements, - reset instrument (long press >5 sec), - switch OFF instrument from standby mode (long press >5 sec).
	<p>Option key is used to:</p> <ul style="list-style-type: none"> - expand column in control panel, - show detailed view of options.
	<p>Shortcut keys for immediate access to the Memory Organizer, Auto Sequences® menu and Single Tests menu.</p>

4.2 General meaning of touch gestures









	<p>Tap (briefly touch surface with fingertip) is used to:</p> <ul style="list-style-type: none"> - select appropriate option, - confirm selected option, - start and stop measurements.
	<p>Swipe (press, move, lift) up/ down is used to:</p> <ul style="list-style-type: none"> - scroll content in same level, - navigate between views in same level.
	<p>Long press (touch surface with fingertip for at least 1 s) is used to:</p> <ul style="list-style-type: none"> - select additional keys (virtual keyboard), - enter cross selector from single test screens.
	<p>Tap Escape icon is used to:</p> <ul style="list-style-type: none"> - return to previous menu without changes, - abort / stop measurements.

4.3 Virtual keyboard



Figure 4.1: Virtual keyboard

Options:

	Toggle case between lowercase and uppercase. Active only when alphabetic characters' keyboard layout selected.
	Backspace Clears last character or all characters if selected. (If held for 2 s, all characters are selected).
	Enter confirms new text.
	Activates numeric / symbols layout.
	Activates alphabetic characters.
	English keyboard layout.
	Greek keyboard layout.
	Russian keyboard layout.
	Returns to the previous menu without changes.

4.4 Safety checks

At start up and during operation the instrument performs various safety checks to ensure safety and to prevent any damage. These safety pre-tests are checking for:

- ▶ Correct input mains voltage
- ▶ Presence of input PE connection,

- ▶ Any external voltage against earth on mains test socket
- ▶ Excessive leakage currents through measuring I/O's,
- ▶ Too low resistance between L and N of tested device,
- ▶ Proper operation of safety relevant internal electronic circuits

If a safety check fails, an appropriate warning message will be displayed and safety measures will be taken. The warnings and safety measures are described in chapter 4.5 *Symbols and messages*.

4.5 Symbols and messages

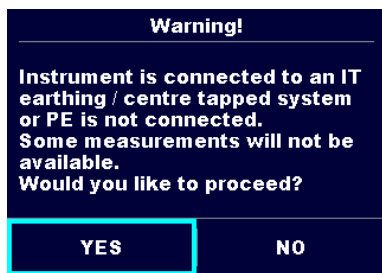

Supply voltage warning

Possible causes:

- ▶ No earth connection.
- ▶ Instrument is connected to an IT earthing system. Press YES to continue normally or NO to continue in a limited mode (measurements are disabled).

Warning:

The instrument must be earthed properly to work safely!

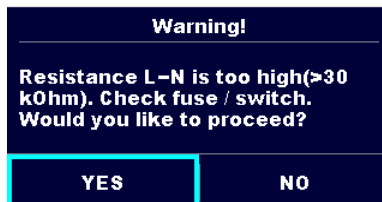

Resistance L-N > 30 k Ω

In pre-test a high input resistance was measured.

Possible causes:

- ▶ Device under test is not connected or switched on
- ▶ Input fuse of device under test is blown.

Select YES to proceed with or NO to cancel measurement.

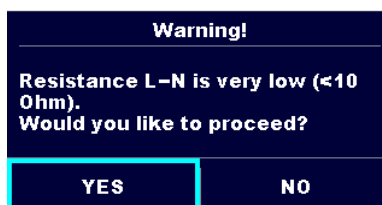

Resistance L-N < 10 Ω

In pre-test a very low resistance of the device under test supply input was measured. This can result in a high current after applying power to the device under test. If the too high current is only of short duration (caused by a short inrush current) the test can be performed otherwise not.

Select YES to proceed with or NO to cancel measurement

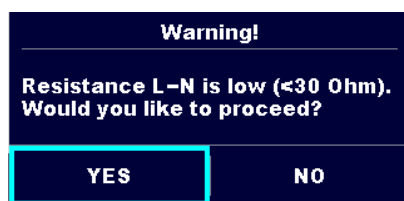

Resistance L-N <math>< 30\ \Omega</math>

In pre-test a low input resistance of the device under test was measured. This can result in a high current after applying power to the device. If the high current is only of short duration (caused by a short inrush current) the test can be performed, otherwise not.

Select YES to proceed with or NO to cancel measurement.

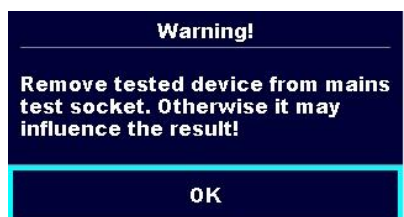

In 2nd step of $I_{\text{ou}}+I_{\text{fi}}$ test the DUT should be disconnected from mains test socket. Disconnect DUT from mains test socket and press OK to continue.

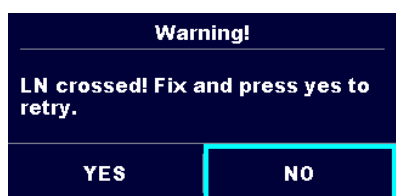

Warning for proper connection in some PRCD measurements. **Connection of PRCD's plug must be changed** in order to proceed.

Select YES to retry after reconnection with or NO to cancel measurement.

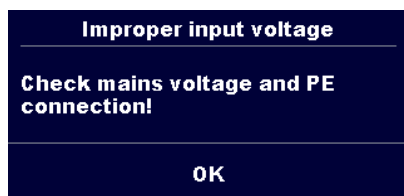

Warning for improper supply voltage condition. If pressed OK, then the instrument will continue to work in a limited mode (measurements are disabled).

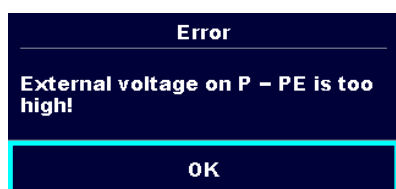

In pre-test a too high external voltage was detected between P and PE terminals. The measurement was cancelled. Press OK to continue.

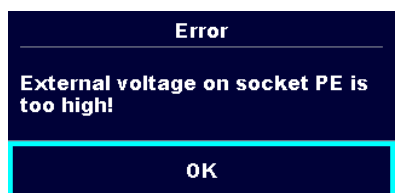

In pre-test a too high external voltage was detected between LN and PE terminals. The measurement was cancelled. Press OK to continue.

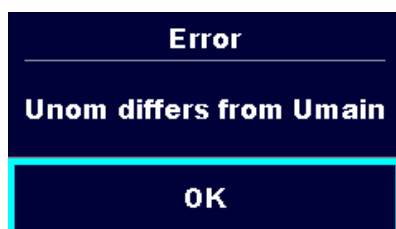

The set U_{nom} differs too much from the measured mains voltage. Parameter or mains voltage must be changed. Press OK to continue.

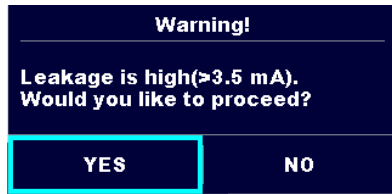

In pre-test a possible high leakage current was detected. It is likely that a dangerous leakage current (higher than 3.5 mA) will flow after applying power to the device under test.

Select YES to proceed with or NO to cancel measurement.

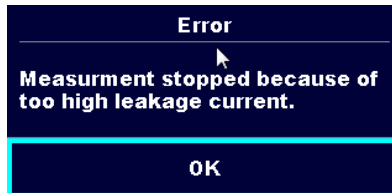

The measured leakage (I_{diff} , I_{pe} , I_{touch} , ...) current was higher than 20 mA. Measurement was aborted. Press OK to continue.

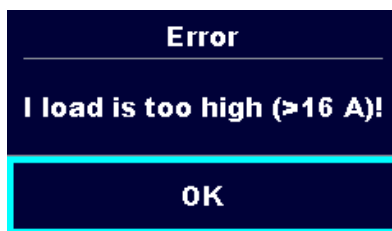

The load current higher than 16 A is detected. Measurement is aborted. Press OK to continue.

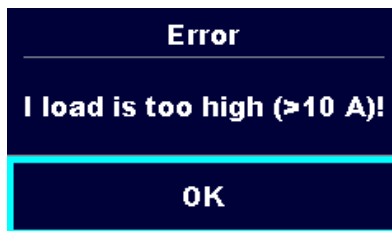

The average load current higher than 10 A over the last 5 min test interval is detected. Measurement is stopped. Recovery period for cooling is required before proceeding with tests! Press OK to continue.

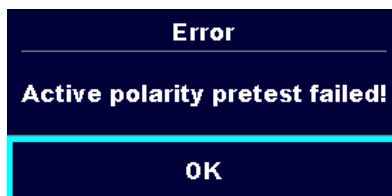

The polarity pre-test of the cable / PRCD has failed. Press OK to continue.

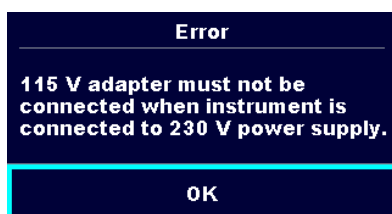













Instrument prohibits the test because 115 V adapter is connected to the instrument and the instrument is powered with 230 V. Press OK to continue.



The instrument is overheated. The measurement can't be carried out until the icon disappears.

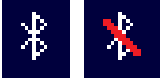

The device under test should be switched on (to ensure that the complete circuit is tested).

	In case of simultaneously measuring of Riso, Riso-S or Isub, Isub-S: If the voltage drops due to one measurement, the other measurement will also be compromised.
	Warning! A high voltage is / will be present on the instrument output! (Withstanding test voltage, Insulation test voltage, or mains voltage).
	Warning! A very high voltage is / will be present on the instrument output! (Flash test voltage).
	Test leads resistance in Continuity / Protective Earth measurement is not compensated.
	Test leads resistance in Continuity / Protective Earth measurement is compensated.
	Measurement can't be started. 3 phase adapter should be disconnected from the instrument.
	Measurement in combination with appropriate 3 phase adapter can be carried out.
	The measurement can be carried out only in combination with appropriate 3 phase adapter.
	Test passed.
	Test failed.
	Conditions on the input terminals allow starting the measurement; consider other displayed warnings and messages.
	Conditions on the input terminals do not allow starting the measurement, consider displayed warnings and messages.
	Stop the measurement.
	Bluetooth communication active / inactive.



Wi-Fi communication active / inactive.

4.6 Fuse checker

Fuse checker, integrated in the OmegaEE XD instrument, is intended for verification of fuses. This functionality is active from any menu, regardless of the instrument settings, as long as the instrument is powered on.

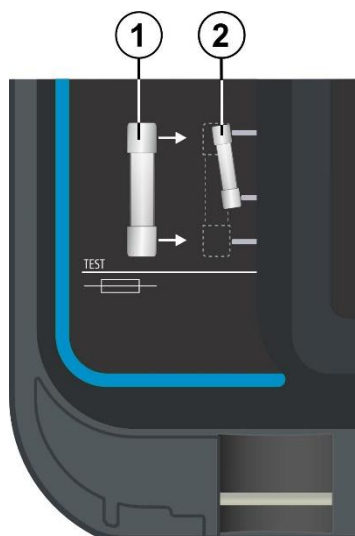

Figure 4.2: Connecting fuses to Fuse checker

Depending on the size of the tested fuse, two test connections are possible. Connection of some typical fuses is defined in table below.

Fuse size (w × d)	Fuse checker test connection position
5 mm × 20 mm	②
5 mm × 25 mm	②
5 mm × 30 mm	①
6.3 mm × 32 mm	①
10 mm × 38 mm	①

Results

Continuous sound	Fuse OK.
No sound	Fuse blown.

4.7 Instrument main menu

From the instrument Main Menu different main operation menus can be selected.

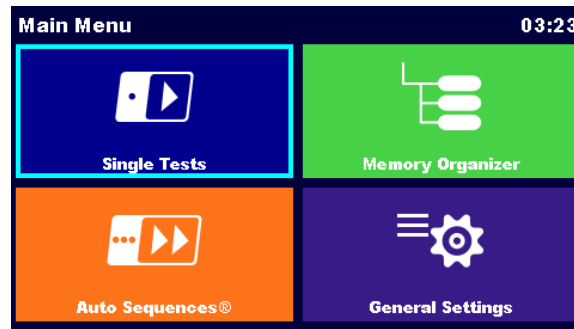

Figure 4.3: Main menu

Options



Single Tests

Menu with single tests, see chapter 6 *Single tests*.

Auto Sequences®

Menu with customized test sequences, see chapter 7 *Auto Sequences®*.

Memory Organizer

Menu for working with and documentation of test data, see chapter 5 *Memory Organizer*.

General Settings

Menu for setup of the instrument, see chapter 4.8 *General settings*.

4.8 General settings

In the General Settings menu general parameters and settings of the instrument can be viewed or set.

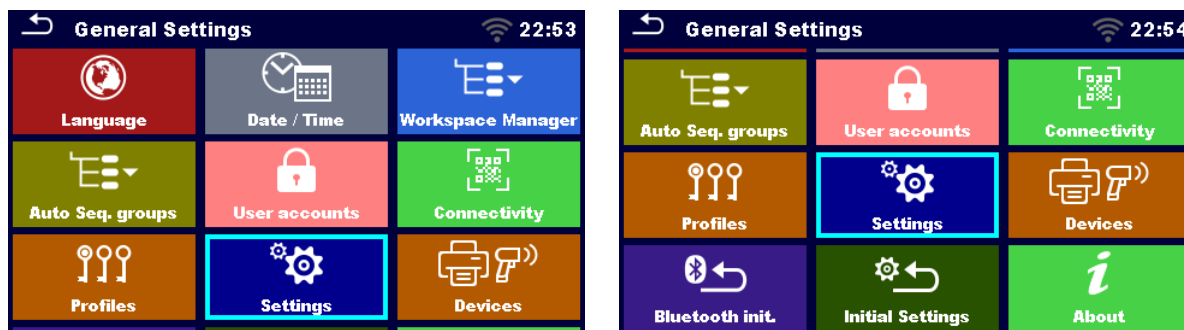













Figure 4.4: Setup menu

Options in General Settings menu

	Language Instrument language selection.
	Date / Time Instruments Date and time.
	Workspace Manager Manipulation with project files. Refer to chapter 4.12 <i>Workspace Manager</i> for more information.
	Auto Sequence® groups Manipulation with lists of Auto Sequences®. Refer to chapter 4.13 <i>Auto Sequence® groups</i> for more information.
	User accounts User account settings.
	Connectivity Menu with QR code link for connection to Metrel Cloud app.
	Profiles Selection of available instrument profiles.
	Settings Setting of different system / measuring parameters.
	Devices Setting of external devices.
	Bluetooth init. Reset Bluetooth module.

 Initial Settings	Initial Settings Factory settings.
 About	About Basic instrument data.

4.8.1 Language

In this menu the language of the instrument can be set. The selection of available languages depends on the selected instrument profile.

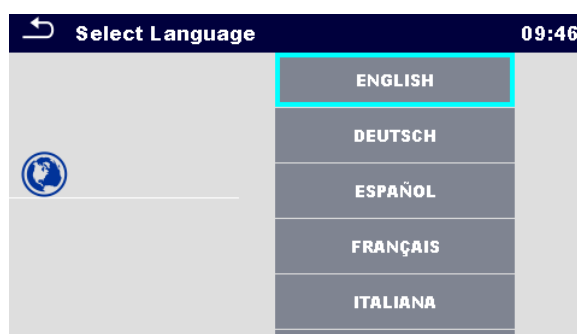

Figure 4.5: Select language menu

4.8.2 Date and time

In this menu date and time of the instrument can be set.

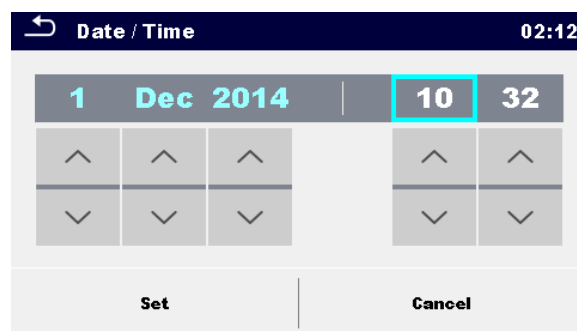

Figure 4.6: Setting data and time menu

4.8.3 Profiles

Refer to *Chapter 4.11 Instrument profiles* for more information.

4.8.4 Workspace Manager

Refer to *Chapter 4.12 Workspace Manager* for more information.

4.8.5 Auto Sequence® groups

Refer to *Chapter 4.13 Auto Sequence® groups* for more information.

4.8.6 Settings



Figure 4.7: Settings menu

Setting options:

	Description
Touch screen	ON – touch screen is active. OFF – touch screen is deactivated.
Keys & touch sound	ON – sound is active. OFF – sound is deactivated.
Equipment ID	Increment – offered ID will be incremented +1. Replicate – offered ID will be the same as last used. Blank – equipment ID will not be offered.
Equipment name	Replicate – offered name will be the same as last used. Blank – equipment name will not be offered.
Retest period	Replicate – offered retest period will be the same as last used. Blank – retest period will not be offered.
RCD Standard	Selection of appropriate standard for RCD tests.
PRCD Standard	Selection of appropriate standard for PRCD tests.
Ch1 clamp type	Setting of current clamp type.
Unom	Nominal Line to earth voltage [100 V, 110 V, 120 V, 220 V, 230 V or 240 V] (is used for normalization of leakage current results if testing medical equipment).
Result	General: Worst – the worst result of the measurement will be displayed at the end of test. Last – last result will be displayed at the end of test. Notes and exceptions:

	<ul style="list-style-type: none"> ▶ In general, the worst result(s) of the main result is considered. Sub-result(s) taken at the same time as the worst case of the main result are displayed. ▶ In the function Leak's & Power the worst case of Idiff and I touch are considered. The Power result measured at the time of worst Idiff is displayed. ▶ In the function Riso, Riso-S and Isub, Isub-S the worst case of Riso and Riso-S and Isub, Isub-S are considered. The Um result measured at the time of worst Riso is displayed. ▶ For the Power measurement the last result is considered regardless of the Result setting. ▶ Active leakage tests (Idiff, Ipe, I touch,...) with (Mains polarity = All) or (Change = YES): <p>Last: worst of all last results of each step is displayed.</p>
Test mode	<p>Standard – Visual and Functional inspection status fields should be set manually.</p> <p>Expert – All Visual and Functional inspection status fields are filled automatically with PASS status.</p>
Auto seq. flow	<p>Ends if fail – Auto Sequence will end after first fail status of measurement / inspection is detected. Proceeding tests will be skipped.</p> <p>Proceeds if fail – Auto Sequence will proceed even if fail status of measurement / inspection is detected.</p>
Device (adapter)	Selection and enabling of external device (adapter) [A1322/A1422, A1694]
Result view	<p>All – all individual measured results and details are shown</p> <p>Standard – the view is similar to older version of leakage measurements.</p> <ul style="list-style-type: none"> - one result for normal and reversed mains is shown - test results made at normal condition are not indicated with 'NC'
Load pretest	<p>ON – DUT connection to test socket is checked before test</p> <p>OFF – DUT connection pretest is omitted.</p>
Bluetooth / Wi-Fi	<p>Enabled – Default setting.</p> <p>Disabled – Instrument not visible to other Bluetooth devices.</p>
Adapter type	<p>None – Default setting.</p> <p>A 1632 – eMobility Analyser connection settings.</p>
Ext. Keyboard	<p>ON – enable external BT keyboard. (See A 1578 manual for details.)</p> <p>OFF – external BT keyboard is disabled.</p>
Limit Uc	Conventional touch voltage limit [Custom, 25 V, 50 V]

4.8.7 Bluetooth initialization

In this menu the Bluetooth module is reset.

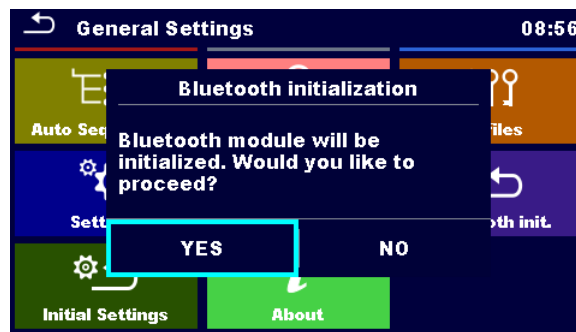

Figure 4.8: Bluetooth initialization menu

4.8.8 Initial Settings

In this menu internal Bluetooth module can be initialized and the instrument settings, measurement parameters and limits can be set to initial (factory) values.

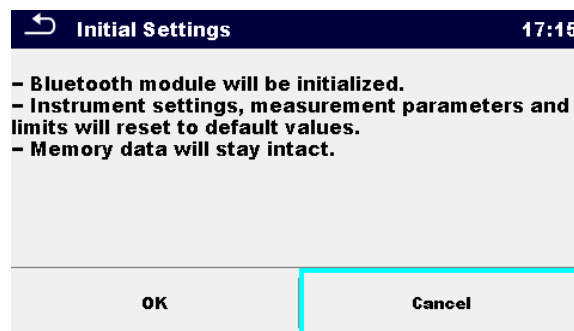

Figure 4.9: Initial settings menu

Warning!

Following customized settings will be lost when setting the instruments to initial settings:

- Measurement limits and parameters
- Global parameters, System settings and Devices in General settings menu
- Opened Workspace and Auto Sequence® group will be deselected.
- User will be signed out.

Note:

Following customized settings will stay:

- Profile settings
- Data in memory (Data in Memory organizer, Workspaces, Auto Sequence® groups and Auto Sequences®)
- User accounts

4.8.9 About

In this menu instrument data (name, serial number, FW (firmware) and HW (hardware) version, profile code, HD (hardware documentation) version, and date of calibration) can be viewed.

About 08:08		About 08:09	
Name	MI 3365 OmegaEE XD	FW version	1.0.5.4218b241
S/N	22052780	FW Profile	EFAB
FW version	1.0.5.4218b241	HW version	1
FW Profile	EFAB	HD version	1
HW version	1	Date of calibration	22.Mar.2023
HD version	1	(C) Metrel, 2023, www.metrel.si	

Figure 4.10: Instrument info screen

Note:

- Adapter info is also displayed if connected.

4.8.10 User Accounts

The demand to sign in can prevent from unauthorized persons to work with the instrument.

In this menu user accounts can be managed:

- Setting if signing in to work with the instrument is required or not.
- Adding and deleting new users, setting user permissions, user names and passwords.

The user accounts can be managed by the administrator.

Factory set administrator password: ADMIN

It is recommended to change factory set administrator password after first use. If the custom password is forgotten the second administrator password can be used. This password always unlocks the Account manager and is delivered with the instrument.

If a user account is set and the user is signed in the user's name will be stored in memory for each measurement.

Individual users can change their passwords.

4.8.10.1 Signing in

If signing in is demanded the user must enter the password in order to work with the instrument.

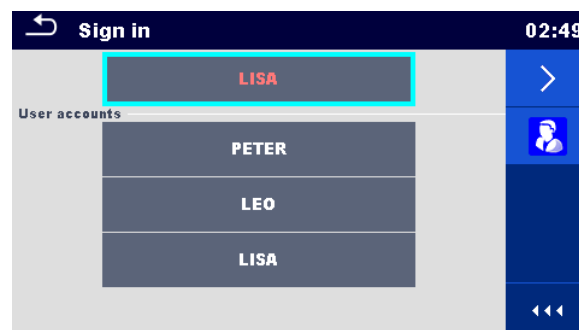
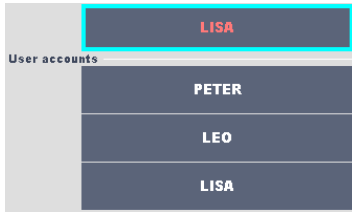

Figure 4.11: Sign in menu

Options

User signing in



The user should be selected first. The last used user is displayed in the first row.



Goes to Password entry menu.



To sign in, the selected user password must be entered and confirmed.

The user password consists of a up to 4-digit number.

Administrator signing in



Enters Account manager menu.



The administrator password must be entered and confirmed first.

Administrator password consists of letters and/or numbers. Letters are case sensitive.

4.8.10.2 Changing user password, signing out

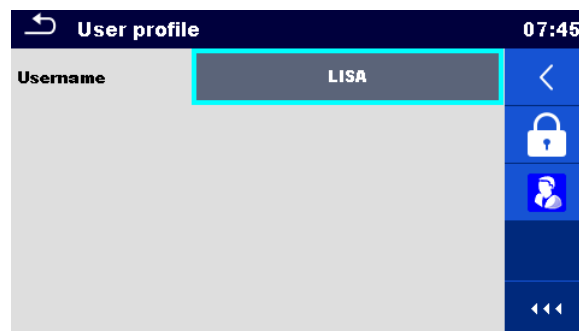

Figure 4.12: User profile menu

Options



Signs out the set user.



Enters procedure for changing the user's password.

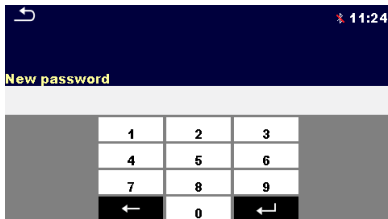

The actual password must be entered first followed by the new password.



Enters the Account manager menu.

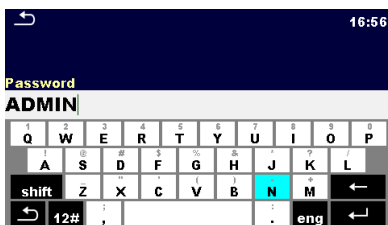

The Account manager menu is accessed by selecting Account Manager in Sign in menu or User profile menu. The administrator password must be entered and confirmed first.

The factory set default administrator password is: ADMIN

4.8.10.3 Managing accounts

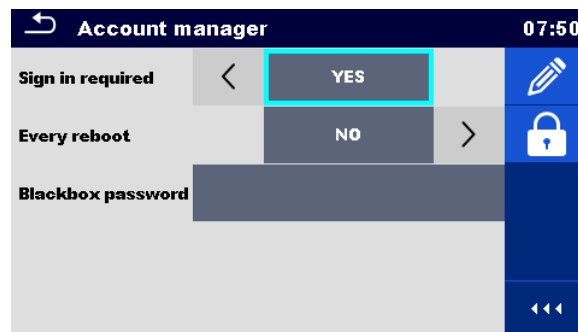

Figure 4.13: Account manager menu

Options



Field for setting if signing in is required to work with the instrument.

Field for setting if signing is required once or at each power on of the instrument.



Enters procedure for changing the administrator password.

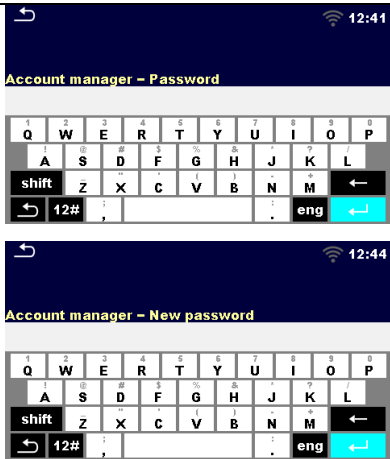

The actual password must be entered first followed by the new password.



Enters menu for editing user accounts.

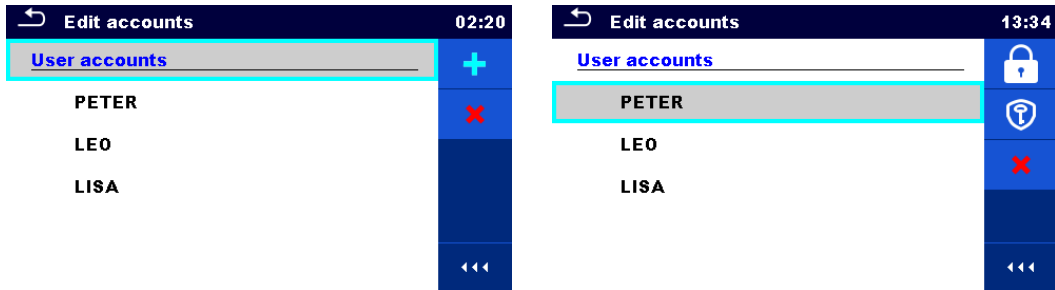
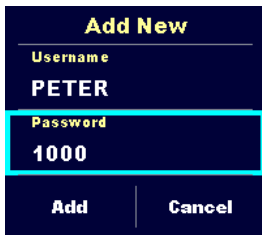

Figure 4.14: Edit accounts menu

Options



Opens the window for adding a new user account.



In the Add New window the name and initial password of the new user account are to be set. 'Add' confirms the new user account.



Changes password of the selected user account.



Enters menu for setting user permissions



Deletes all user accounts.
Deletes the selected user account.

4.8.11 Setting user permissions

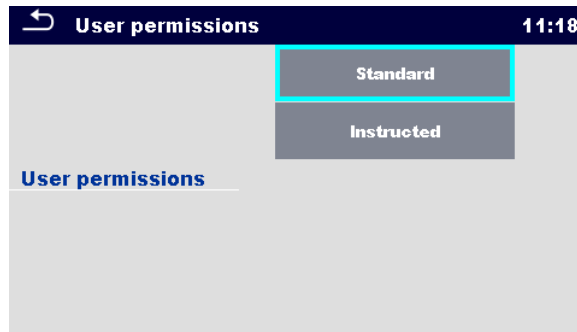

Figure 4.15: User permissions menu

Options



Options with different user permissions. For more information see *Appendix G - User permissions*

4.8.12 Setting Black-box password

Black-box password can be set by administrator from the Account manager menu. Set Black-box password is valid for all users. Default Black-box password is empty (disabled).

Options

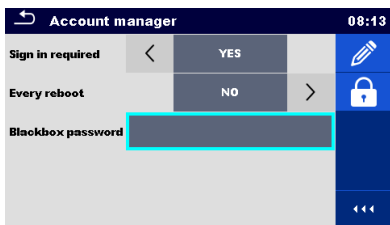

Add or edit Black-box password. Enter to modify.

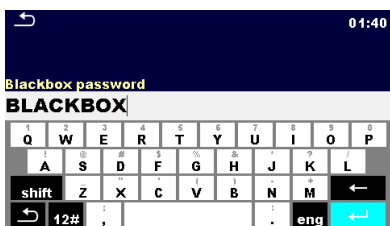

Keyboard for entering new Black-box password is opened. Empty string disables password. Confirm entry.

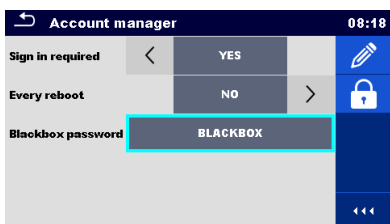

Black-box password is changed.

4.9 Connectivity

In this menu QR code link for connection to Metrel Cloud app is displayed. Refer to Metrel Cloud help for more information.

Note

- Metrel Cloud app is available for Android and iOS.



Google Play



App Store

4.10 Devices

In this menu operation with external devices is configured.

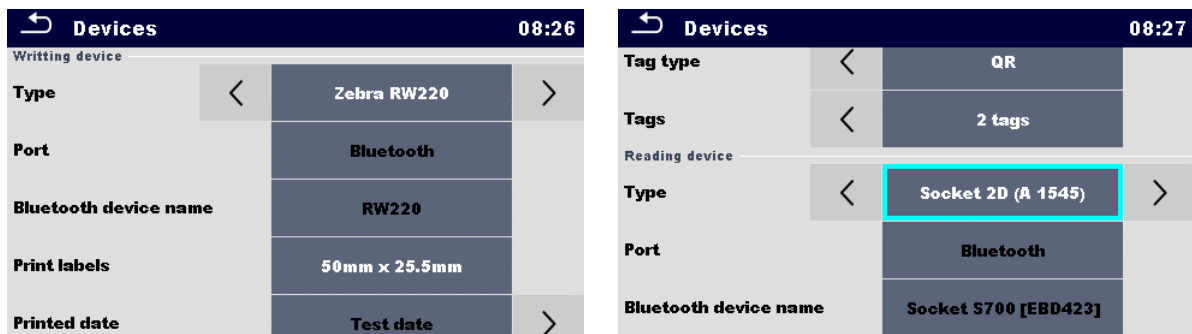

Figure 4.16: Devices settings menu

Writing devices	
Type	Sets appropriate writing device (Serial printer, Bluetooth printer), RFID writer).
Port	Sets/views communication port of selected writing device.
Bluetooth device name	Goes to menu for pairing with selected Bluetooth device.
Bluetooth dongle	Initializes Bluetooth Dongle.
Print labels	Selects label form size. See <i>Appendix C Print labels and write / read RFID / NFC tags</i> for details.
Printed date	Selects date printed on label text area, Options: [Test date, Retest date]. See <i>Appendix C Print labels and write / read RFID / NFC tags</i> for details.

Auto save	Sets simultaneous saving of finished Auto Sequence when label is printed or RFID / NFC tag is written. Options: [On print, On write, OFF] See chapter 7.2.3 <i>Auto Sequence® result screen</i> for details.
Tag format	Sets PAT tag / label format or generic tag /label format. See <i>Appendix C Print labels and write / read RFID / NFC tags</i> for details.
Tag type	Selects tag type to be printed, Options: [simple, classic, QR] See <i>Appendix C Print labels and write / read RFID / NFC tags</i> for details.
Tags	Selects number of tags, Options: [1 tag, 2 tags] See <i>Appendix C Print labels and write / read RFID / NFC tags</i> for details.

Reading devices	
Type	Sets appropriate reading device (QR or barcode scanner, RFID reader, android device via aMESM application).
Port	Sets/views communication port of selected reading device.
Bluetooth device name	Goes to menu for pairing with selected Bluetooth device.

4.11 Instrument profiles

In this menu the instrument profile can be selected from the available ones.

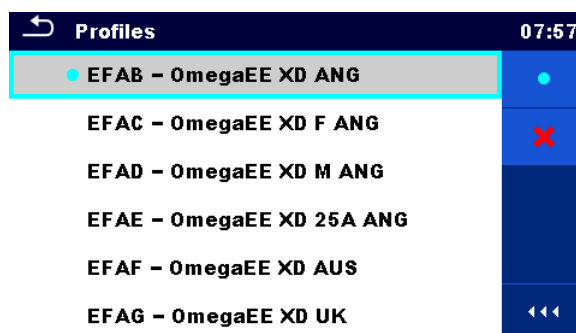

Figure 4.17: Instrument profile menu

The instrument uses different specific system and measuring settings in regard to the scope of work or country it is used. These specific settings are stored in instrument profiles.

By default, each instrument has at least one profile activated. Proper licence keys must be obtained to add more profiles to the instrument.

If different profiles are available, they can be selected in this menu.

Refer to *Appendix B Profile Notes* for more information about functions specified by profiles.

Options



Loads the selected profile. The instrument will restart automatically with new profile loaded.

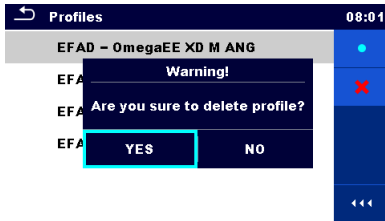

Enters option for deleting a profile.

Before deleting the selected profile, user is asked for confirmation.

4.12 Workspace Manager

The Workspace Manager is intended to manage with different Workspaces and Exports stored on the microSD card.

4.12.1 Workspaces and Exports

The works with OmegaEE XD can be organized with help of Workspaces and Exports. Exports and Workspaces contain all relevant data (measurements, parameters, limits, structure objects) of an individual work.

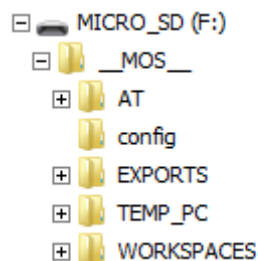

Figure 4.18: Organization of Workspaces and Exports on microSD card

Workspaces are stored on microSD card on directory WORKSPACES, while Exports are stored on directory EXPORTS. Export files can be read by Metrel applications that run on other devices. Exports are suitable for making backups of important works or can be used for storage of works if the removable microSD card is used as a mass storage device. To work on the instrument an Export should be imported first from the list of Exports and converted to a Workspace. To be stored as Export data a Workspace should be exported first from the list of Workspaces and converted to an Export.

4.12.2 Workspace Manager main menu

In Workspace manager Workspaces and Exports are displayed in two separated lists.

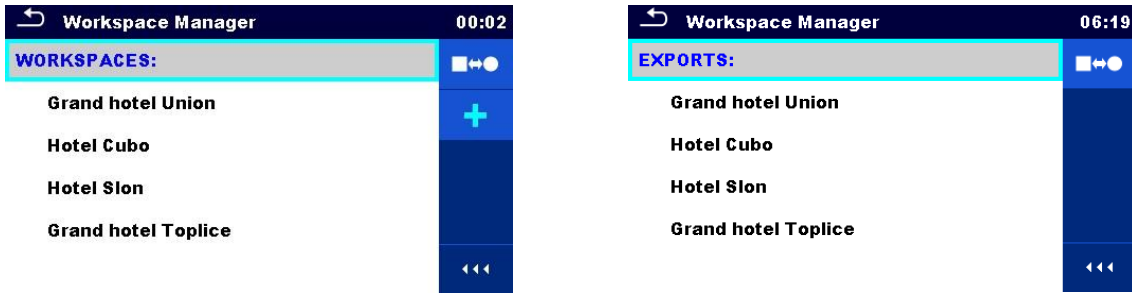

Figure 4.19: Workspace manager main menu

Options

	List of Workspaces.
	Displays a list of Exports.
	Adds a new Workspace. Refer to Chapter <i>Adding a new Workspace</i> for more information.
	List of Exports.
	Displays a list of Workspaces.

4.12.2.1 Operations with Workspaces



Only one Workspace can be opened in the instrument at the same time. The Workspace selected in the Workspace Manager will be opened in the Memory Organizer.



Figure 4.20: Workspaces menu

Options

	Marks the opened Workspace in Memory Organizer.
	Opens the selected Workspace in Memory Organizer. Refer to chapters <i>5 Memory Organizer</i> and <i>Opening a Workspace</i> for more information.

	Deletes the selected Workspace. Refer to chapter Deleting a Workspace / Export
	Adds a new Workspace. Refer to chapter 4.10.2.3. <i>Adding a new Workspace</i> for more information.
	Exports a Workspace to an Export. Refer to chapter <i>Exporting a Workspace</i> for more information.
	Opens options in control panel / expands column.

4.12.2.2 Operations with Exports

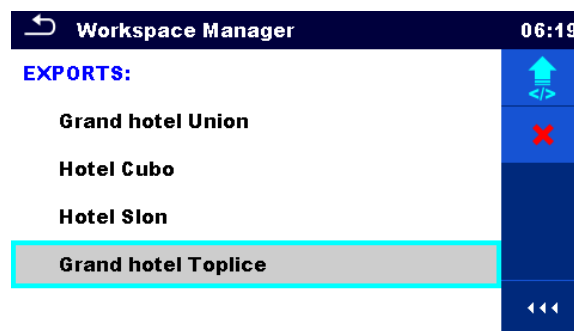





Figure 4.21: Workspace manager File menu

Options

	Deletes the selected Export. Refer to chapter <i>Deleting a Workspace / Export</i> for more information.
	Imports a new Workspace from Export. Refer to chapter <i>Importing a Workspace</i> for more information.
	Opens options in control panel / expands column.

4.12.2.3 Adding a new Workspace



New workspaces can be added from the Workspace manager screen.



Enters option for adding new Workspace.

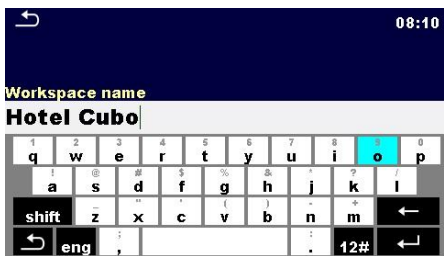

Keypad for entering name of a new Workspace is displayed after selecting New.



After confirmation a new Workspace is added in the list in Main Workspace Manager menu.

4.12.2.4 Opening a Workspace



Workspace can be selected from a list in Workspace manager screen.







Opens a Workspace in Workspace manager.



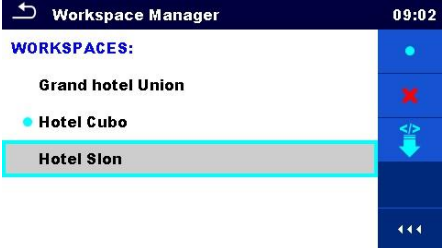

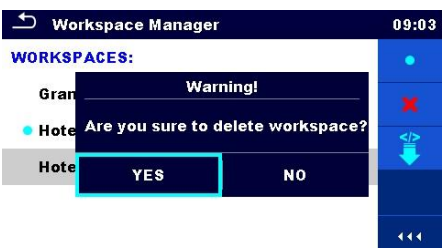
The opened Workspace is marked with a blue dot. The previously opened Workspace will close automatically.

4.12.2.5 Deleting a Workspace / Export

<p>①</p> 	<p>Workspace / Export to be deleted should be selected from the list of Workspaces / Exports. Opened workspace can't be deleted.</p>
<p>②</p>  	<p>Enters option for deleting a Workspace / Export. Before deleting the selected Workspace / Export the user is asked for confirmation.</p>
<p>③</p> 	<p>Workspace / Export is removed from the Workspace / Export list.</p>

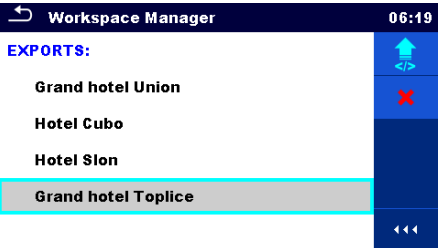
4.12.2.6 Importing a Workspace

<p>①</p> 	<p>Select an Export file to be imported from Workspace Manager Export list.</p>
<p>②</p> 	<p>Enters option Import.</p>

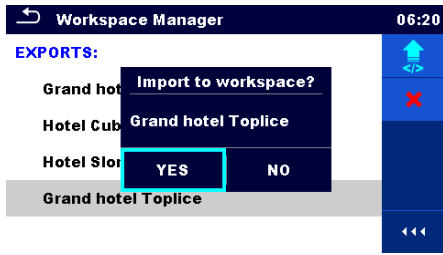

Before the import of the selected file the user is asked for confirmation.



The Imported Export file is added to the list of Workspaces.

Note:

If a Workspace with the same name already exists the name of the imported Workspace will be changed (name_001, name_002, name_003...).

4.12.2.7 Exporting a Workspace



Select a Workspace from Workspace manager list to be exported to an Export file.



Enters option Export.



Before exporting the selected Workspace, the user is asked for confirmation.

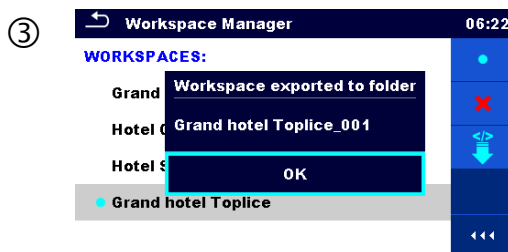

Workspace is exported to Export file and is added to the list of Exports.

Note:

If an Export file with the same name already exists the name of the Export file will be changed (name_001, name_002, name_003, ...).

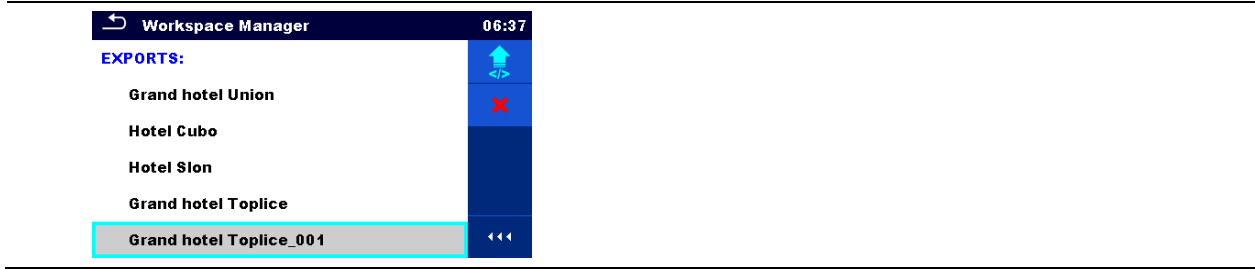

4.13 Auto Sequence® groups

The Auto Sequences® in OmegaEE XD can be organized by using lists. In a list a group of similar Auto Sequences® is stored. The Auto Sequence® groups menu is intended to manage with different lists of Auto Sequences® that are stored on the microSD card.

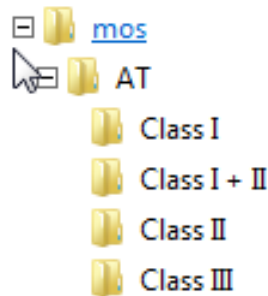

Figure 4.22: Organization of Auto Sequences® on microSD card

Folders with lists of Auto Sequences® are stored in *Root__MOS__\AT* on the microSD card.

4.13.1 Auto Sequence® groups menu

In Auto Sequence® groups menu lists of Auto Sequences® are displayed. Only one list can be opened in the instrument at the same time. The list selected in the Auto Sequence® groups menu will be opened in the Auto Sequences® main menu.

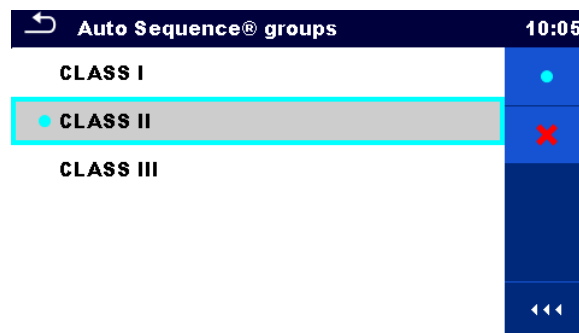

Figure 4.23: Auto Sequence® groups menu

4.13.1.10 Operations in Auto Sequence® groups menu

Options



Opens the selected list of Auto Sequences®. Previously selected list of Auto Sequences® will be closed automatically.

Refer to chapter *Selecting a list of Auto Sequences®* for more information.



Deletes the selected list of Auto Sequences.

Refer to chapter *Deleting a list of Auto Sequences®* for more information.



Opens options in control panel / expands column.

4.13.1.2 Selecting a list of Auto Sequences®

①

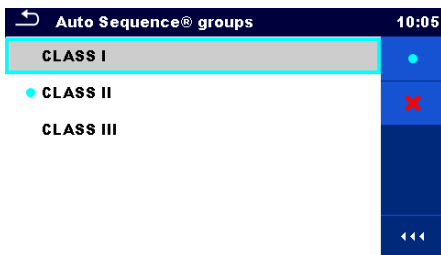

A list of Auto Sequences® can be selected from the Auto Sequence® groups menu.

②



Enters option for selecting a list.

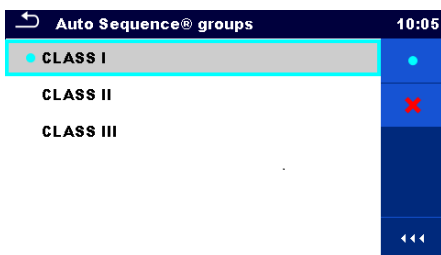

Selected list of Auto Sequences® is marked with a blue dot.

Note:

Previously selected list of Auto Sequences® is closed automatically.

4.13.1.3 Deleting a list of Auto Sequences®

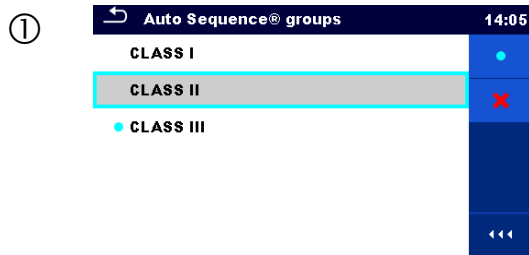

A list of Auto Sequences® to be deleted can be selected from the Auto Sequence® groups menu.



Enters option for deleting a list.

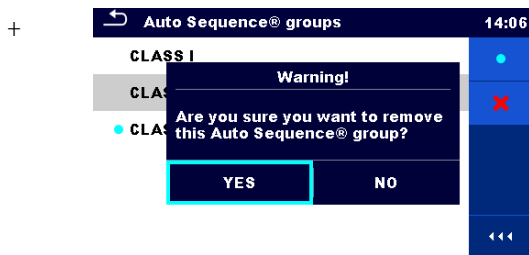

Before deleting the selected list of Auto Sequences® the user is asked for confirmation.

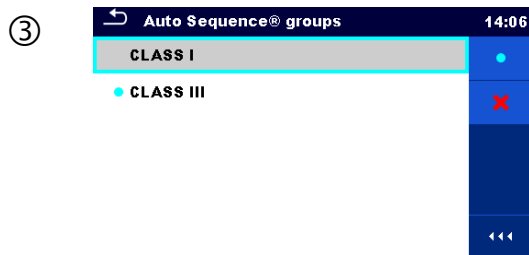

A list of Auto Sequences® is removed.

5 Memory Organizer

Memory Organizer is a tool for storing and working with test data.

5.1 Memory Organizer menu

The data is organized in a tree structure with Structure objects and Measurements. OmegaEE XD has a multi-level structure. The hierarchy of Structure objects in the tree is shown on *Figure 5.1*. For a list of available structure objects see *Appendix A Structure objects in OmegaEE XD*.

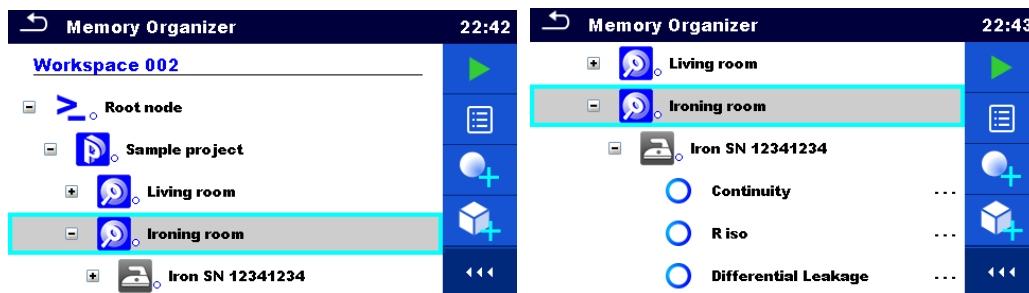

Figure 5.1: Tree structure and its hierarchy

5.1.1 Measurement statuses





Each measurement has:

- ▶ a status (Pass or Fail or no status)
- ▶ a name
- ▶ results
- ▶ limits and parameters









A measurement can be a Single test or an Auto Sequence.

For more information, refer to chapters *6 Single tests* and *7 Auto Sequences®*.

Statuses of Single tests

	passed finished single test with test results
	failed finished single test with test results
	finished single test with test results and no status
	empty single test without test results

Overall statuses of Auto Sequence

 or 	at least one single test in the Auto sequence passed and no single test failed
 or 	at least one single test in the Auto sequence failed
 or 	at least one single test in the Auto sequence was carried out and there were no other passed or failed single tests
 or 	empty Auto sequence with empty single tests

5.1.2 Structure Objects

Each Structure object has:

- ▶ an icon
- ▶ a name
- ▶ parameters

Optionally they can have:

- ▶ an indication of the status of the measurements under the Structure object
- ▶ a comment or a file attached

Structure objects supported are described in *Appendix A Structure objects in OmegaEE XD*.



Figure 5.2: Structure object in tree menu

5.1.2.1 Measurement status indication under the Structure object

Overall status of measurements under each structure element / sub-element can be seen without spreading tree menu. This feature is useful for quick evaluation of test status and as guidance for measurements.

Options



There are no measurement result(s) under selected structure object. Measurements should be made.



Figure 5.3: Example of status - No measurement result(s)



One or more measurement result(s) under selected structure object has failed. Not all measurements under selected structure object have been made yet.

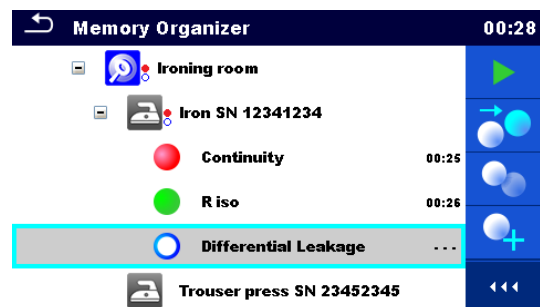

Figure 5.4: Example of status - Measurements not completed with fail result(s)



All measurements under selected structure object are completed but one or more measurement result(s) has failed.



Figure 5.5: Status - Measurements completed with fail result(s)





Note:

- There is no status indication if all measurement results under each structure element / sub-element have passed or if there is an empty structure element / sub-element (without measurements).

5.1.3 Selecting an active Workspace in Memory Organizer

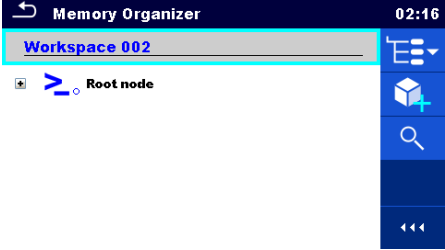
Memory Organizer and Workspace Manager are interconnected so an active Workspace can be selected also in the Memory Organizer menu.

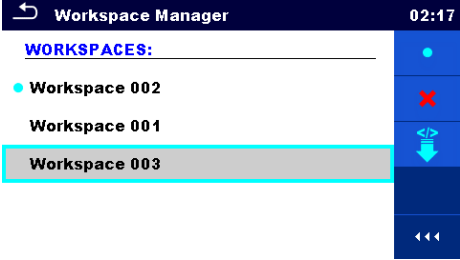

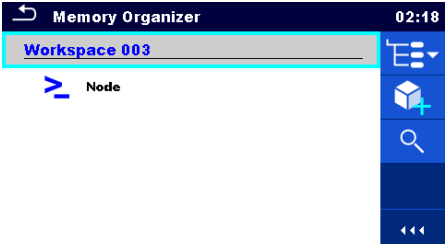
Procedure

- ①  Press the active Workspace in Memory Organizer Menu.
- ②  Select List of Workspaces in Control panel.
- ③  Choose desired Workspace from a list of Workspaces.
- ④  Use Select button to confirm selection.
- ⑤  New Workspace is selected and displayed on the screen.

5.1.4 Adding Nodes in Memory Organizer

Structural Elements (Nodes) are used to ease organization of data in the Memory Organizer. One Node is a must; others are optional and can be created or deleted freely.

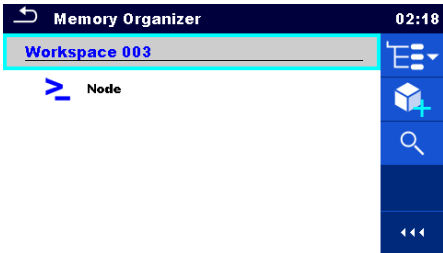
Procedure

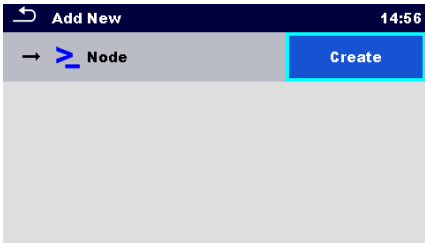
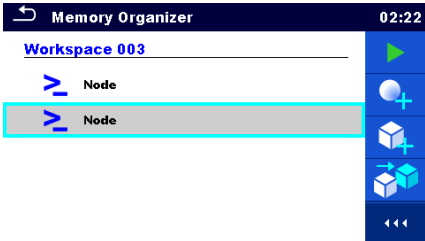
- ①  Press the active Workspace in Memory Organizer Menu.
- ②  Select Add New Structure Element in Control panel.
- ③  Press "Create" to confirm.
- ④  New Structure Element (Node) is added.
Note:
To change the name of a Node, see chapter *Rename a Structure object*.

5.1.5 Operations in Tree Menu

In the Memory organizer different actions can be taken with help of the control panel at the right side of the display. Possible actions depend on the selected element in the organizer.

5.1.5.1 Operations on measurements (finished or empty measurements)

The measurement must be selected first. Operation options can be selected from the menu on the right side of the screen. Menu options are adapted to measurement status, empty, finished, finished and saved, as presented on *Figure 5.6*.

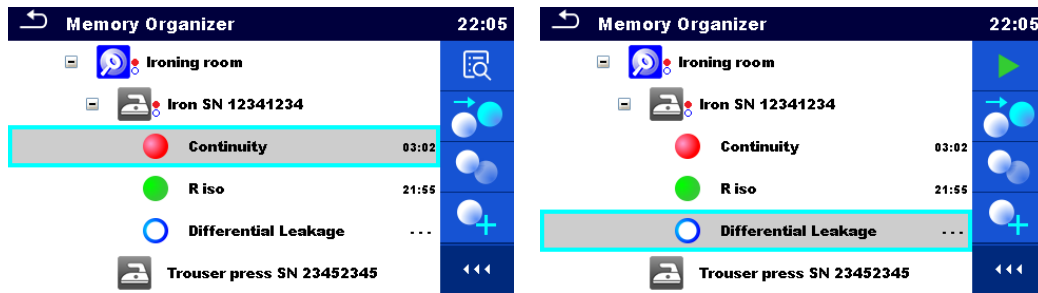

Figure 5.6: A measurement is selected in the tree menu

Options



Views results of measurement.

The instrument goes to the measurement memory screen. Refer to chapters *Single test memory screen* and *7.2.4 Auto Sequence® memory screen* for more information.



Starts a new measurement.

The instrument goes to the measurement start screen. Refer to chapters *Single test start screen* and *7.2.1 Auto Sequence® view menu* for more information.



Saves a measurement.

Saving of measurement on a position after the selected (empty or finished) measurement.



Clones the measurement.

The selected measurement can be copied as an empty measurement under the same Structure object. Refer to *Chapter Clone a measurement* for more information.



Copies & Paste a measurement.

The selected measurement can be copied and pasted as an empty measurement to any location in structure tree. **Multiple “Paste” is allowed.** Refer to *Chapter Copy & Paste a measurement* for more information.



Adds a new measurement.

The instrument goes to the Menu for adding measurements. Refer to *Chapter Add a new measurement* for more information.



Views and edit comments.

The instrument displays comment attached to the selected measurement or opens keypad for entering a new comment.



Deletes a measurement.

Selected Measurement can be deleted. User is asked for confirmation before the deleting. Refer to *Chapter Delete a measurement* for more information.

5.1.5.2 Operations on Structure objects

The structure object must be selected first.

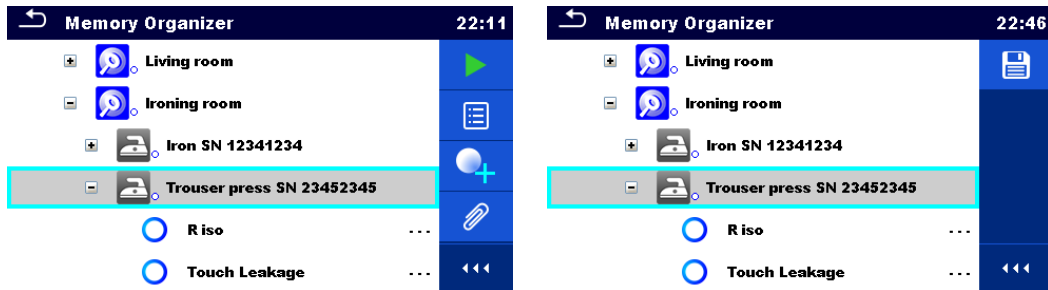

Figure 5.7: A structure object is selected in the tree menu

Options



Starts a new measurement.
First type of measurement (single test or Auto sequence®) should be selected. After proper type is selected the instrument goes to single test or Auto Sequence® selection screen. Refer to *Chapters 6.1 Selection modes and 7.1 Selection of Auto Sequences®* for more information.



Saves a measurement.
Saving of measurement under the selected Structure object.



View / edit parameters and attachments.
Parameters and attachments of the Structure object can be viewed or edited. Refer to Chapter *View / Edit parameters and attachments of a Structure object* for more information.



Adds a new measurement.
The instrument goes to the Menu for adding measurement into structure. Refer to *Chapter Add a new measurement* for more information.



Adds a new Structure object.
A new Structure object can be added. Refer to Chapter *Add a new Structure Object* for more information.



Attachments.
Name and link of attachment is displayed.



Clones a Structure object.
Selected Structure object can be copied to same level in structure tree (clone). Refer to *Chapter Clone a Structure object* for more information.

- 

Copies & Paste a Structure object.

Selected Structure object can be copied and pasted to any allowed location in structure tree. **Multiple “Paste” is allowed.** Refer to *Chapter Copy & Paste a Structure object* for more information.
- 

Cut & Paste a Structure.

Selected Structure with child items (sub-structures and measurements) can be moved to any allowed location in structure tree. Refer to chapter *Cut & Paste a Structure object with sub-items* for more information.
- 

Views and edit comments.

The instrument displays comment attached to the selected Structure object or opens keypad for entering a new comment.
- 

Deletes a Structure object.

Selected Structure object and sub-elements can be deleted. User is asked for confirmation before the deleting. Refer to Chapter *Delete a Structure object* for more information.
- 

Renames a Structure object.

Selected Structure object can be renamed via keypad. Refer to *Chapter Rename a Structure object* for more information.

5.1.5.3 View / Edit parameters and attachments of a Structure object

The parameters and their content are displayed in this menu. To edit the selected parameter, tap on it or press RUN key to enter menu for editing parameters.



Parameters

Memory Organizer / Parameters
00:22

IT Equipment

Appliance ID	IT Equipment
Inventory No.	PC 12344321
Name	PC / Monitor
Location (Room)	Living room

Figure 5.8: Example of View / Edit parameters menu

Procedure and options

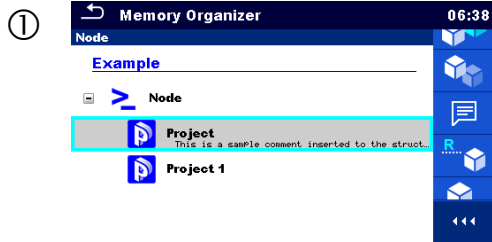

Select structure object to be edited.



Select Parameters in Control panel.

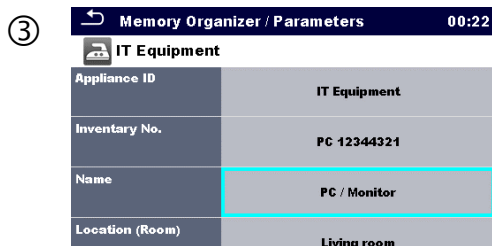

Example of Parameters menu.

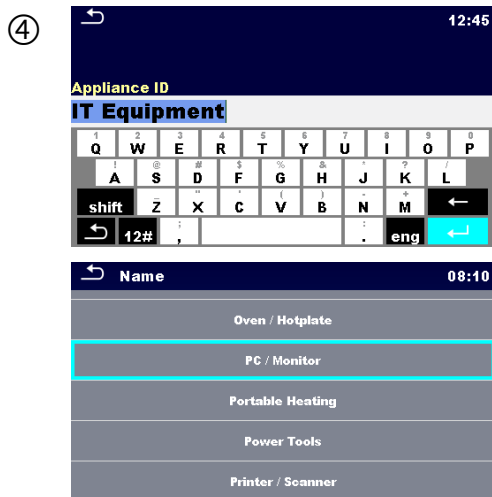

In menu for editing parameters the parameter's value can be selected from a dropdown list or entered via keypad. Refer to chapter 4 *Instrument operation* for more information about keypad operation.



Select Attachments in Control panel.

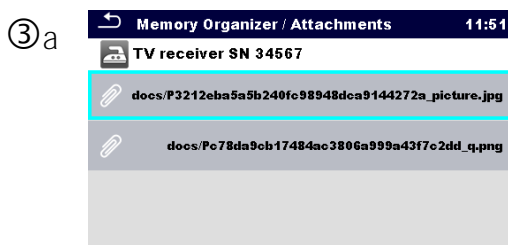

Attachments

The name of attachment can be seen. Operation with attachments is not supported in the instrument.



Select Comments in Control panel.

③b



View or edit comments

Complete comment (if exists) attached to the structure object can be seen on this screen.

Press RUN key or tap on screen to open keypad for entering a new comment.

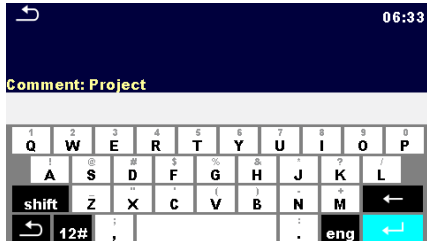

5.1.5.4 Add a new Structure Object

This menu is intended to add new structure objects in the tree menu. A new structure object can be selected and then added in the tree menu.

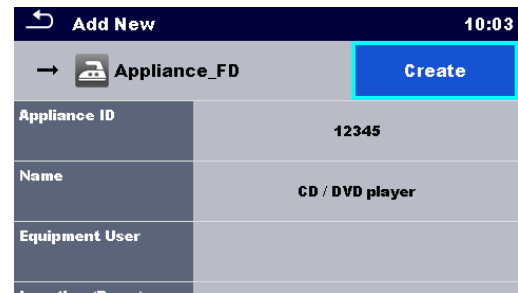
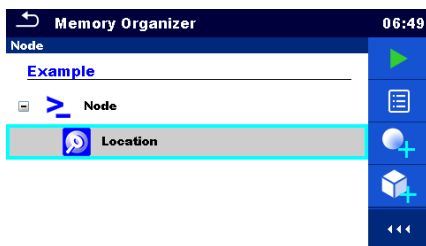

Figure 5.9: Add a new Structure Object menu

Procedure and options

①



Default initial structure.

②



Select Add Structure in Control panel.



Add a new structure object menu.

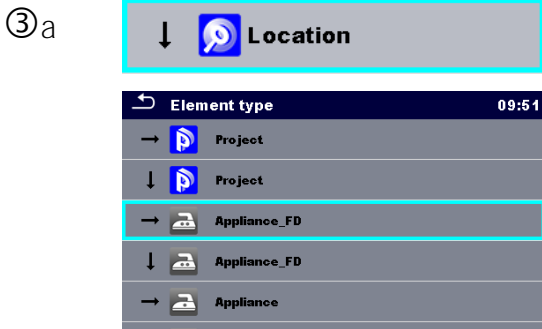

Tap on a structure type selection window.

A list of available structure items is displayed. Select one from a list. Arrow indicates the position where structure item will be inserted.



Child item to the currently selected structure item.



Structure item located in the same level.

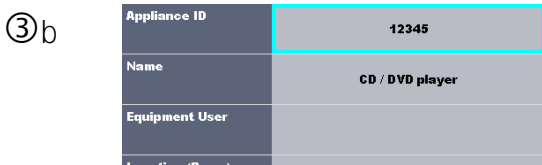

In menu for editing name and parameters the parameter's value can be selected from a dropdown list or entered via keypad. Refer to chapter 4 *Instrument operation* for more information about keypad operation.

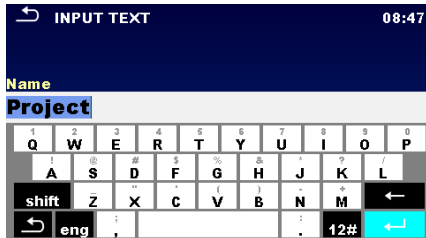

Create new structure item.

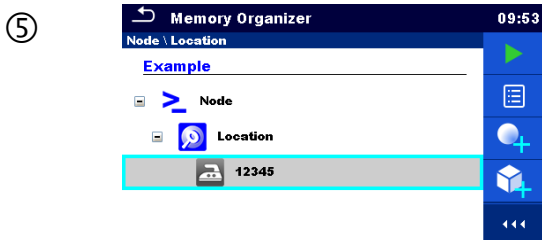

New object added.

5.1.5.5 Add a new measurement

In this menu new empty measurements can be set and then added in the structure tree. The type of measurement, measurement function and its parameters are first selected and then added under the selected Structure object.



Figure 5.10: Add a new measurement menu

Procedure and options

- ①

Select level in structure where measurement will be added.

- ②

Select Add measurement in Control panel.

- ③

Add new measurement menu.

- ③a

Type of test can be selected from this field.
Options: (Single Tests, Auto Sequences®)
Tap on field or press the RUN key to modify.

- ③b

Last added measurement is offered by default.

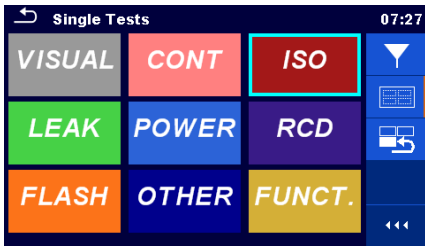

To select another measurement, tap on filed or press the RUN to open menu for selecting measurements. Refer to *Chapters 6.1 Selection modes and 7.1 Selection of Auto Sequences* for more information.

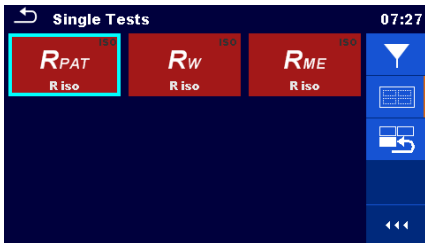

③c



Select parameter and modify it as described earlier.

Refer to *Chapter Setting parameters and limits of single tests* for more information.

④



Adds the measurement under the selected Structure object in the tree menu.

Returns to the structure tree menu without changes.

⑤

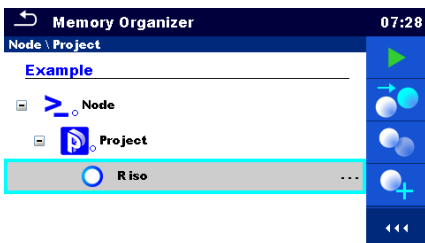

New empty measurement is added under the selected Structure object.

5.1.5.6 Clone a Structure object

In this menu selected structure object can be copied (cloned) to same level in the structure tree. Cloned structure object has same name as original.



Figure 5.11: Clone Structure Object menu

Procedure and options

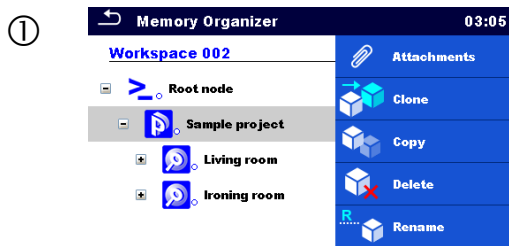

Select the structure object to be cloned.



Select Clone option from control panel.

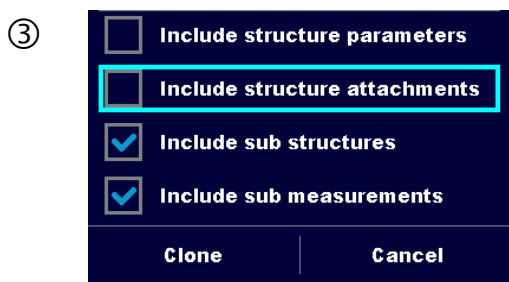

The Clone Structure object menu is displayed. Sub-elements of the selected structure object can be marked or un-marked for cloning. Refer to *Chapter Copy & Paste a Structure object* for more information.



Selected structure object is copied (cloned) to same level in the structure tree.

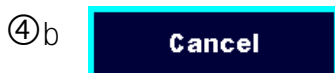

Cloning is cancelled. No changes in the Structure tree.



The new structure object is displayed.

5.1.5.7 Clone a measurement

By using this function, a selected empty or finished measurement can be copied (cloned) as an empty measurement to the same level in the structure tree.

Procedure and options

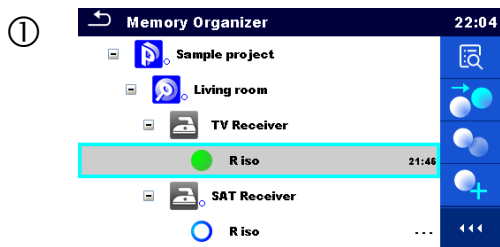

Select the measurement to be cloned.



Select Clone option from control panel.

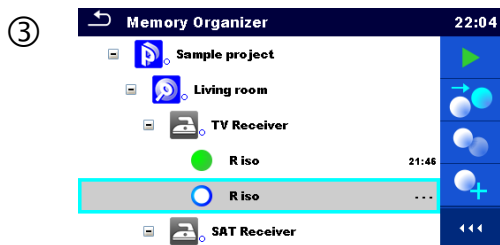





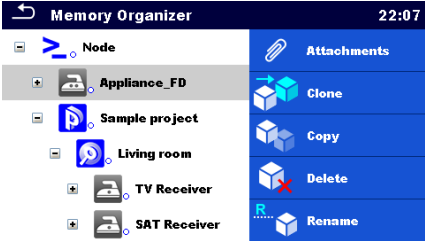

The new empty measurement is displayed.

5.1.5.8 Copy & Paste a Structure object

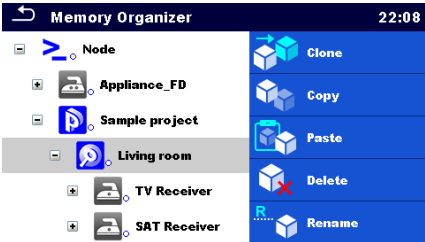
In this menu selected Structure object can be copied and pasted to any allowed location in the structure tree.

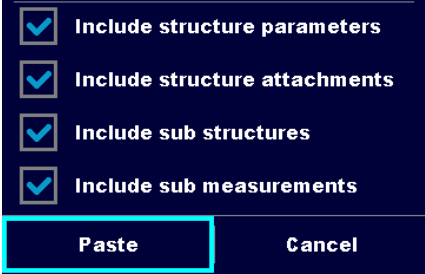
Procedure and options

- | | | |
|----|---|--|
| ① |  | Select the structure object to be copied. |
| ② |  Copy | Select Copy option from control panel. |
| ③ |  | Select location where structure element should be copied. |
| ④ |  Paste | Select Paste option from control panel. |
| ⑤ |  | The Paste structure object menu is displayed. Before copying it can be set which sub-elements of the selected structure object will be copied too. For more details see options below. |
| ⑥a |  | The selected structure object and elements are copied (pasted) to selected position in the tree structure. |
| ⑥b |  | Returns to the tree menu without changes. |

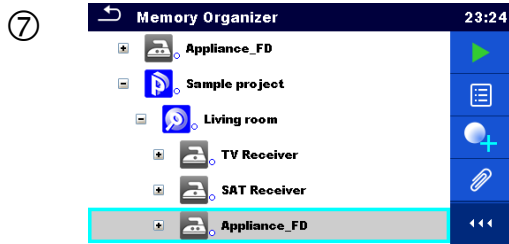

The new structure object is displayed.

Note:

The Paste command can be executed one or more times.

Options



Parameters of selected structure object will be copied too.



Attachments of selected structure object will be copied too.



Structure objects in sub-levels of selected structure object will be copied too.



Measurements in selected structure object and sub-levels will be copied too.

5.1.5.9 Copy & Paste a measurement

In this menu selected measurement can be copied to any allowed location in the structure tree.

Procedure



Select the measurement to be copied.



Select Copy option from control panel.



Select location where measurement should be pasted.

④



Paste

Select Paste option from control panel.

⑤



The new (empty) measurement is displayed in selected Structure object.

Note:

The Paste command can be executed one or more times.

5.1.5.10 Cut & Paste a Structure object with sub-items

In this menu selected Structure object with sub-items (sub-structures and measurements) can be cut and pasted (moved) to any allowed location in the structure tree.

Procedure

①

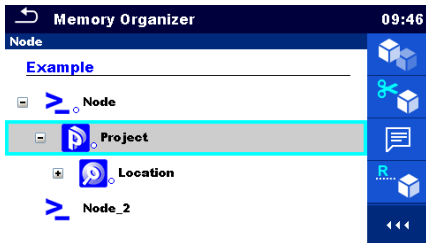

Select the structure item to be moved.

②



Cut

Select Cut option from Control panel.

③

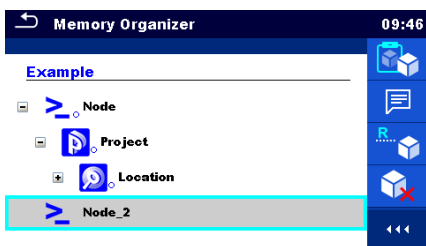

Select new location where structure object (with sub-structures and measurements) should be moved.

④



Paste

Select Paste option from Control panel.

⑤

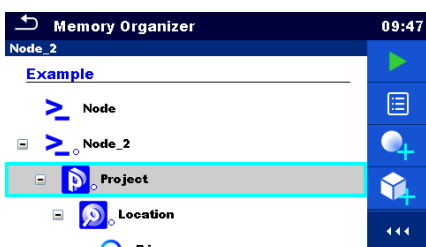





The structure object (with sub-structures and measurements) is moved to selected new location and deleted from previous location in the tree structure.

5.1.5.11 Delete a Structure object

In this menu selected Structure object can be deleted.

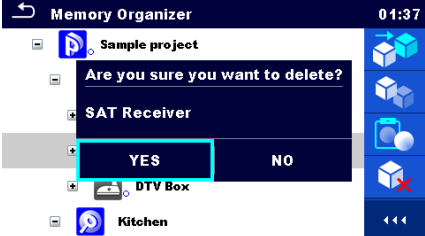



Procedure

- | | | |
|----|---|---|
| ① |  | Select the structure object to be deleted. |
| ② | 
Delete | Select Delete option from control panel. |
| ③ |  | A confirmation window will appear. |
| ④a |  | Selected structure object and its sub-elements are deleted. |
| ④b |  | Returns to the tree menu without changes. |

5.1.5.12 Delete a measurement

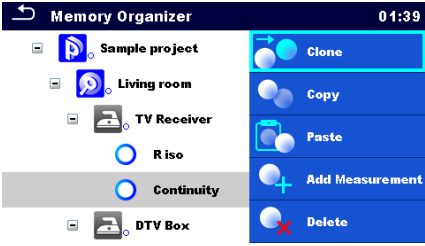
In this menu selected measurement can be deleted.

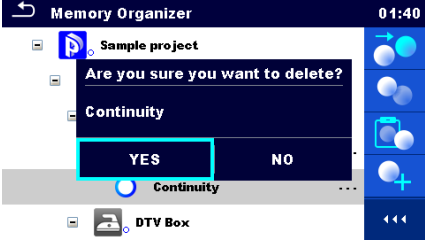
Procedure

- | | | |
|----|---|---|
| ① |  | Select a measurement to be deleted. |
| ② |  | Select Delete option from control panel. |
| ③ |  | A confirmation window will appear. |
| ④a |  | Selected measurement is deleted. |
| ④b |  | Returns to the tree menu without changes. |

5.1.5.13 Rename a Structure object

In this menu selected Structure object can be renamed.

Procedure

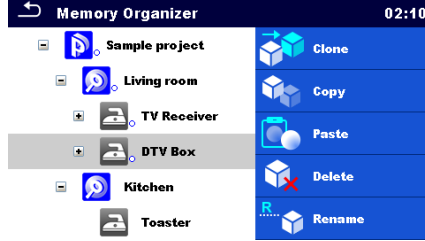
- | | | |
|---|---|--|
| ① |  | Select the structure object to be renamed. |
|---|---|--|

②  Rename
Select Rename option from control panel.

③  Virtual keypad will appear on screen. Enter new text and confirm.

5.1.5.14 Recall and Retest selected measurement

Procedure

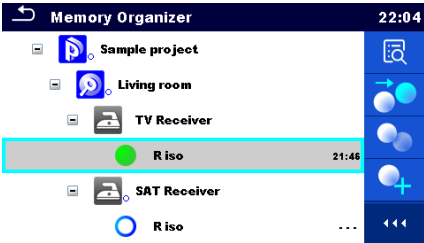
①  Select the measurement to be recalled.

②  Recall results
Select Recall results in control panel.

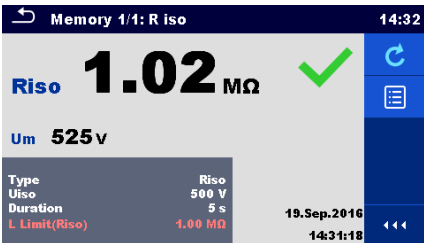
③  Measurement is recalled.
Parameters and limits can be viewed but cannot be edited.

④  Retest
Select Retest in control panel.

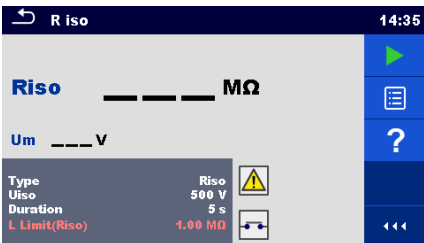
⑤  Measurement retest starting screen is displayed.

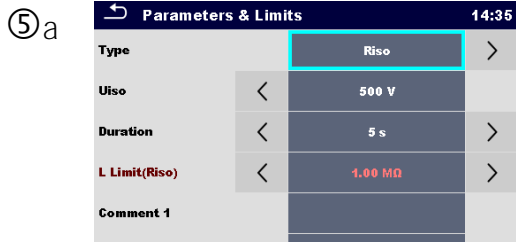

Parameters and limits can be viewed and edited.



Select Run in control panel to retest the measurement.

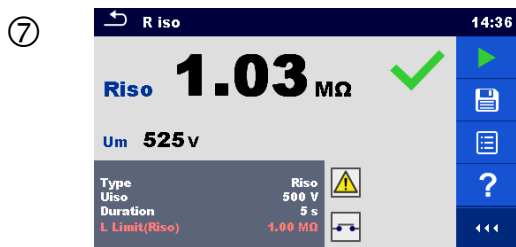

Results / sub-results after re-run of recalled measurement.



Select Save results in control panel.

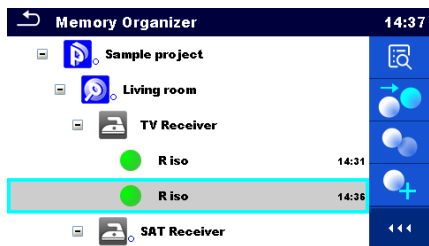

Retested measurement is saved under same structure item as original one.

Refreshed memory structure with the new performed measurement is displayed.

5.1.6 Searching in Memory Organizer

In Memory organizer it is possible to search for different structure objects and parameters.

Procedure



Search function is available from the active workspace directory line.

Use external device for data entry or follow instructions below for instrument search function.



Select Search in control panel to open Search setup menu.

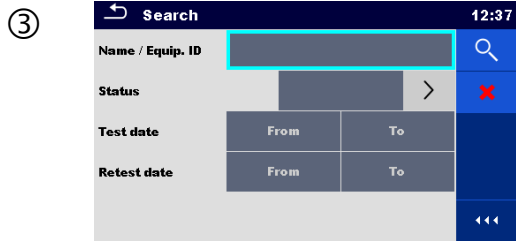

The parameters that can be searched for are displayed in the Search setup menu.

Note:

- Equipment ID, Test date and Retest date (if applicable) refer only to the following structure objects: Appliance, Appliance FD, Medical equipment, Medical equipment FD, Welding equipment and Welding equipment FD.



The search can be narrowed by entering a text in the Name and Equipment ID field.

Strings can be entered using the on-screen keyboard.

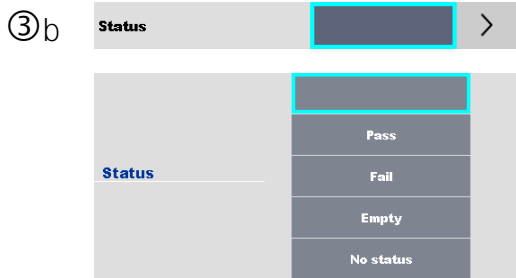

The search can be narrowed on base of statuses.

If searching by status, instrument will display all structure objects that include one or more measurements with searched status.

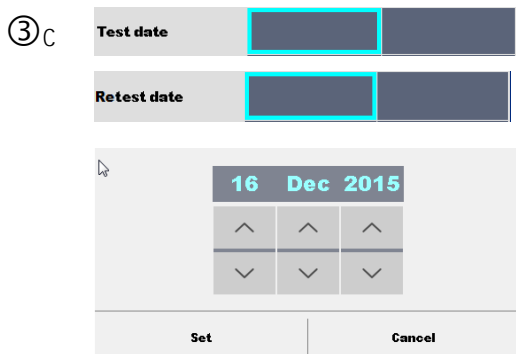

The search can be narrowed on base of test dates / retest dates (from / to).



Clears all filters. Sets filters to default value.



Searches through the Memory Organizer for objects according to the set filters. The results are shown in the Search results screen presented on *Figure 5.12* and *Figure 5.13*.

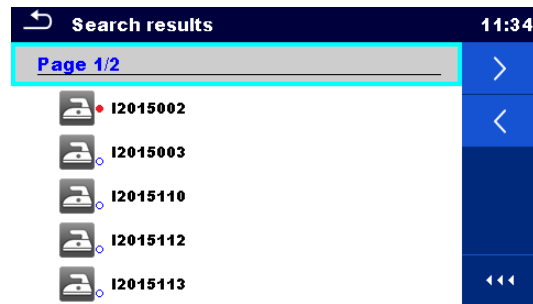

Figure 5.12: Search results screen – Page view

Options



Next page.



Previous page.

Note:

Search result page consist of up to 50 results.

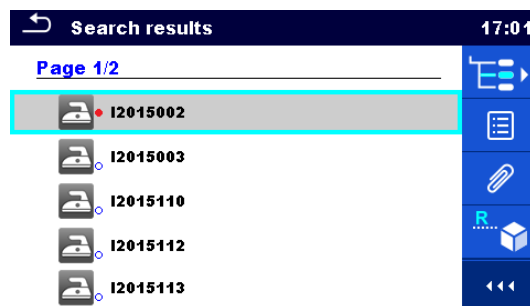

Figure 5.13: Search results screen with structure object selected

Options



Goes to location in Memory Organizer.



View / edit parameters and attachments.
Parameters and attachments of the Structure object can be viewed or edited. Refer to Chapter *View / Edit parameters and attachments of a Structure object* for more information.



Attachments.
Name and link of attachment is displayed.



Views comment.
The instrument displays comment attached to the selected Structure object.



Renames the selected Structure object.
Refer to *Chapter Rename a Structure object* for more information.

6 Single tests

Single tests can be selected in the Main single test menu or in Memory Organizer's main and submenus.

6.1 Selection modes

In Single tests main menu Area group and three different modes for selecting single tests are available.

Options

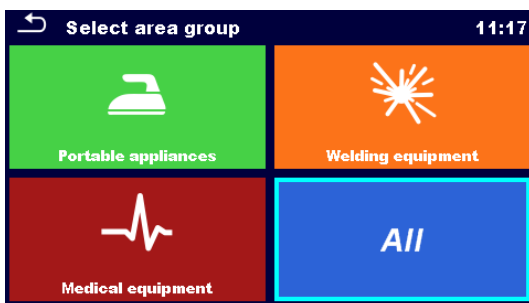

Area Group

With help of area groups, it is possible to limit the offered single tests. The instrument has four area groups:

- ▶ *Portable appliances*
- ▶ *Medical equipment*
- ▶ *Welding equipment*
- ▶ *All*

Group *All* combine all single tests.

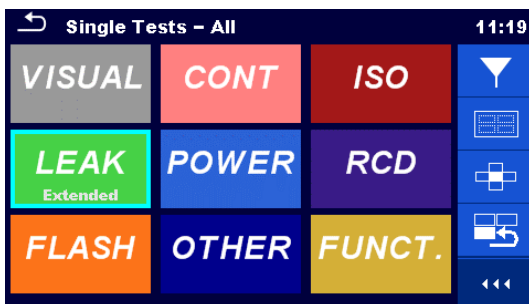

Groups

The single tests are divided into groups of similar tests within selected Area group.

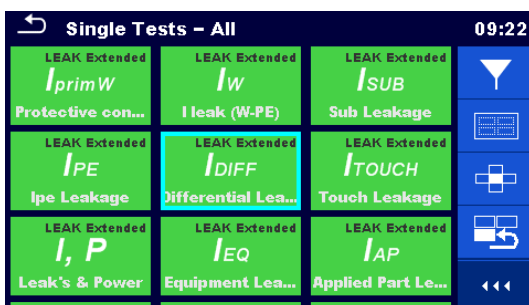

For the selected group a submenu with all single tests that belongs to the selected group and Area group is displayed.

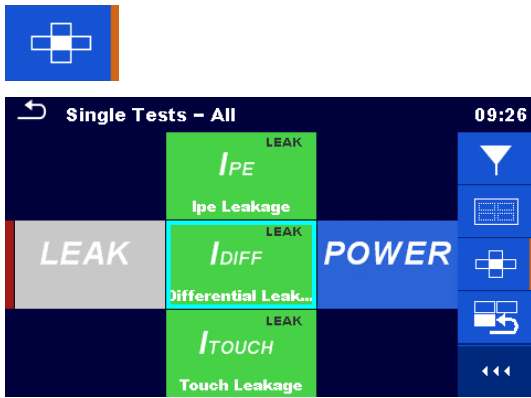

Cross selector

This selection mode is the fastest for working with the keypad.

Groups of single tests are organized in a row.

For the selected group all single tests are displayed and easy accessible with up /down keys.

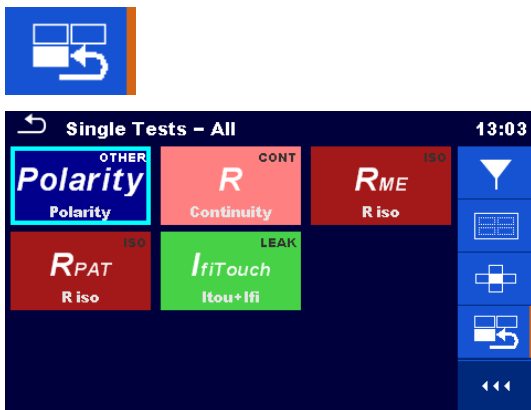

Last used

Up to last 9 different executed single tests within selected Area group are displayed.

6.1.1 Single test screens

In the Single test screens measuring results, sub-results, limits and parameters of the measurement are displayed. In addition, on-line statuses, warnings and other information are displayed.

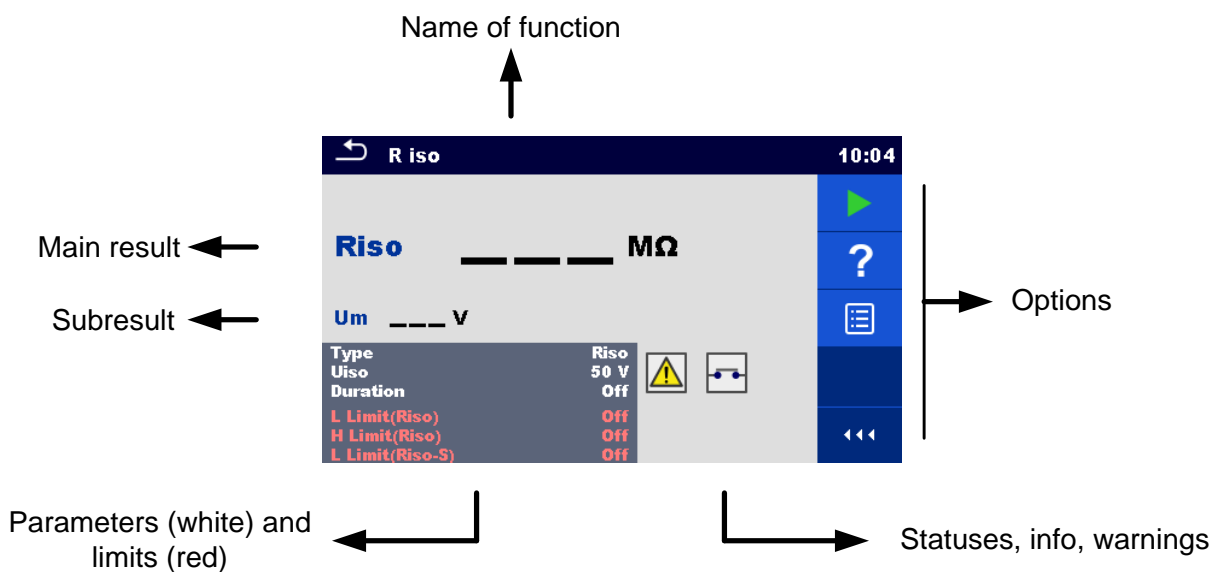

Figure 6.1: Single test screen organisation

6.1.1.1 Single test start screen

Single test start screen can be opened from Memory organizer or from Single test main menu.

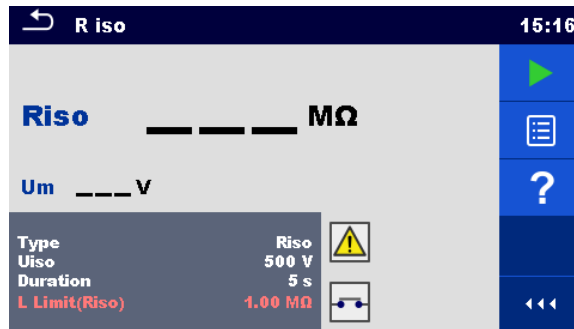

Figure 6.2: Single test start screen

Options



Starts the measurement.



Opens help screens. Refer to chapter 6.1.3 Help screens for more information.



Opens menu for changing parameters and limits. Refer to chapter Setting parameters and limits of single tests for more information.

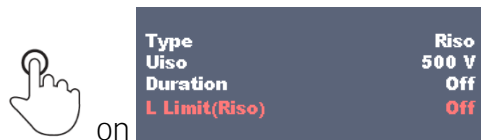

6.1.1.2 Setting parameters and limits of single tests

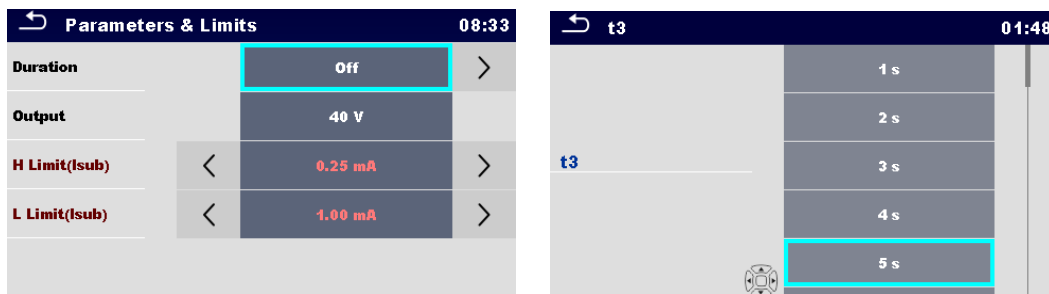
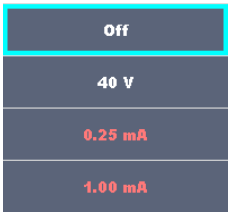
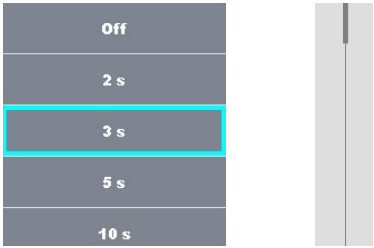
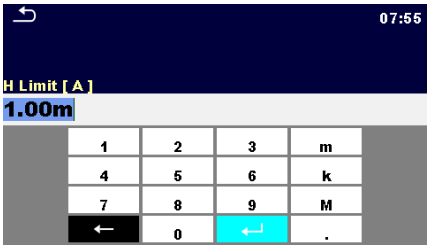

Figure 6.3: Screens in menu for setting Single test parameters and limits

Options

	<p>Selects parameter (white) or limit (red).</p>
	<p>Selects value of parameter or limit. In case of many (multiple pages of) parameters or limits:</p> <ul style="list-style-type: none"> - The scroll bar on the right side of screen can be used - With right / left keys it can be jumped page up / page down
	<p>Enters custom value of parameter or limit. Custom values can be entered by using the on-screen keyboard.</p>

6.1.1.3 Single test screen during test

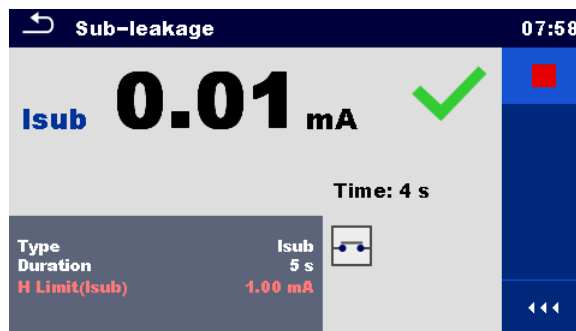







Figure 6.4: Single test screen (during measurement)

Options (during test)

 or 	<p>Stops the single test measurement.</p>
 or 	<p>Proceeds to the next step of the measurement (if measurement consists of more steps).</p>
 or 	<p>Measurement is paused. Proceeds to the next step (optional) of the measurement.</p>



Aborts measurement.

6.1.1.4 Single test result screen

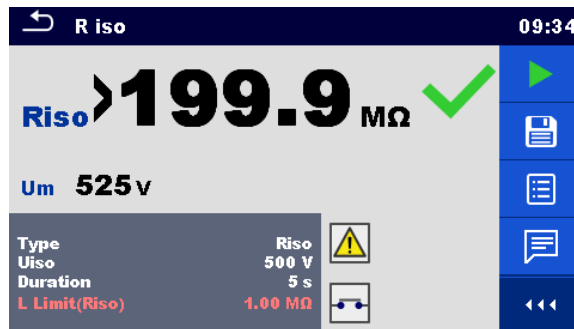

Figure 6.5: Single test result screen

Options (after measurement is finished)



Starts a new measurement.



Saves the result.

A new measurement was selected and started from a Structure object in the structure tree:

- The measurement will be saved under the selected Structure object.

A new measurement was started from the Single test main menu:

- Saving under the last selected Structure object will be offered by default. The user can select another Structure object or create a new Structure

object. By pressing the  key in Memory organizer menu the measurement is saved under selected location.

An empty measurement was selected from structure tree and started:

- The result(s) will be added to the measurement. The measurement will change its status **from 'empty' to 'finished'**.

An already carried out measurement was selected from structure tree, viewed and then restarted:

- A new measurement will be saved under the selected Structure object.



Adds comment to the measurement. The instrument opens keypad for entering a comment.



Opens help screens. Refer to chapter 6.1.3 *Help screens* for more information.



Opens screen for changing parameters and limits.
Refer to chapter *Setting parameters and limits of single tests* for more information.



on

Type	Riso
Uiso	500 V
Duration	5 s
L Limit(Riso)	1.00 MΩ



Enters cross selector. Refer to chapter 6.1 *Selection modes* for more information.



long on

Riso	>199.9 MΩ
Um	525 v

6.1.1.5 Single test memory screen

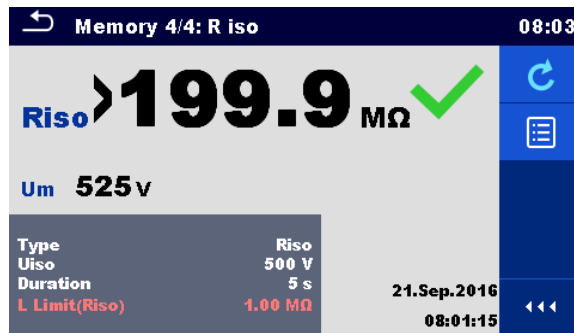

Figure 6.6: Single test memory screen

Options



Opens menu for viewing parameters and limits.
Refer to chapter *Setting parameters and limits of single tests* for more information.



on

Type	Riso
Uiso	500 V
Duration	5 s
L Limit(Riso)	1.00 MΩ



or

Retest
Enters screen with “empty” measurement.

6.1.2 Single test (inspection) screens

Visual and Functional inspections can be treated as a special class of tests. Items to be visually or functionally checked are displayed. In addition, on-line statuses and other information are displayed.

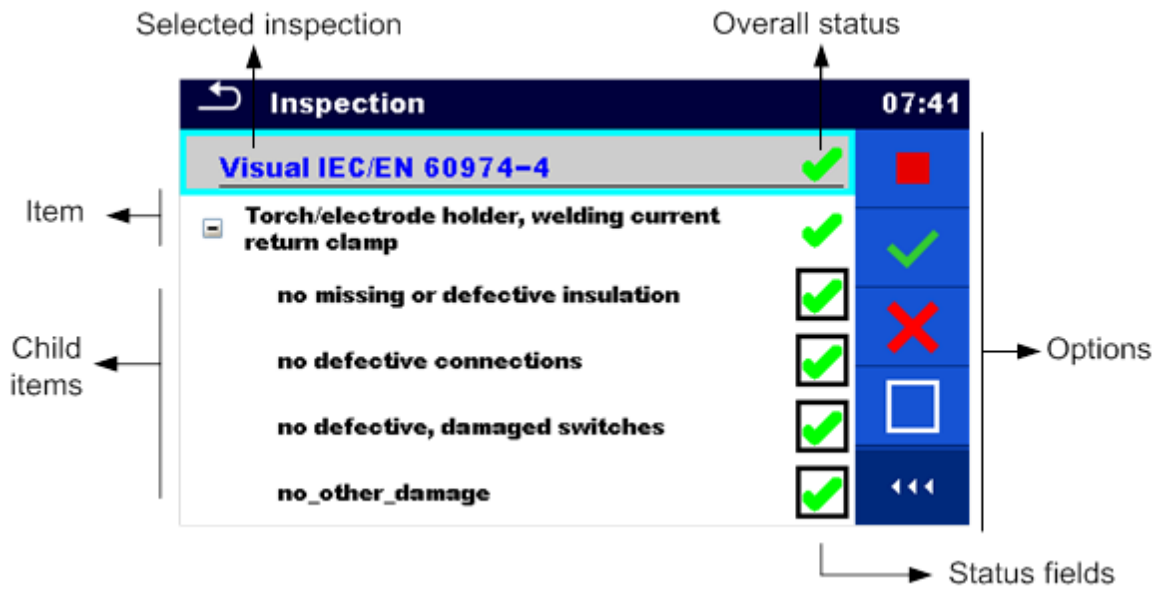

Figure 6.7: Inspection screen organisation

6.1.2.1 Single test (inspection) start screen

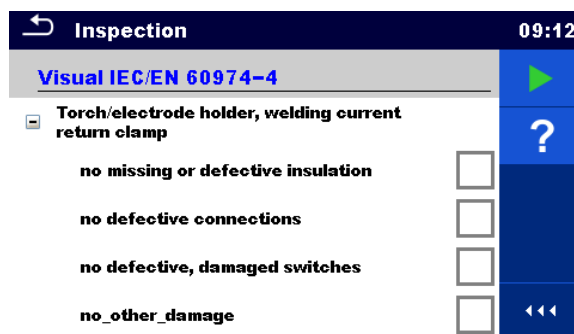

Figure 6.8: Inspection start screen

Options (inspection screen was opened in Memory organizer or from Single test main menu):



Starts the inspection.



Opens help screens. Refer to chapter 6.1.3 Help screens for more information.

6.1.2.2 Single test (Inspection) screen during test

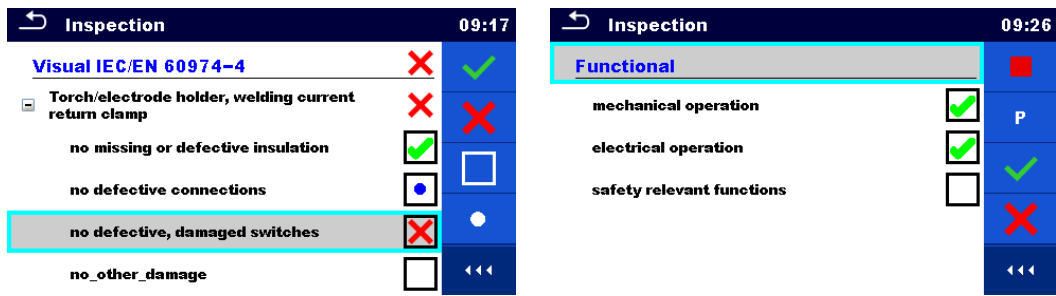

Figure 6.9: Inspection screen (during inspection)

Options (during test)

	Selects item.
	Applies a pass to the selected item or group of items.
	Applies a fail to the selected item or group of items.
	Clears status in selected item or group of items.
	Applies a status that item or group of items was checked.
	A status can be applied. Multiple taps toggles between statuses.
	Toggle between statuses.
	Power is applied to the mains test socket to power up the tested equipment during a functional inspection. The instrument displays and starts the Power measurement, refer to <i>Chapter 6.2.11 Power</i> .
	Stops Power measurement. Stops the inspection.
	Stops the inspection. Goes to the result screen.

Rules for automatic applying of statuses:

- › The parent item(s) can automatically get a status on base of statuses in child items.
 - The fail status has highest priority. A fail status for any item will result in a fail status in all parent items and an overall fail result.
 - If there is no fail status in child items the parent item will get a status only if all child items have a status.
 - Pass status has priority over checked status.
- › The child item(s) will automatically get a status on base of status in the parent item
 - All child items will get the same status as applied to the parent item.

Note

- › Inspections and even inspection items inside one inspection can have can have different status types. For example, **some basic inspections don't have the 'checked' status.**
- › Only inspections with overall statuses can be saved.

6.1.2.3 Single test (Inspection) result screen

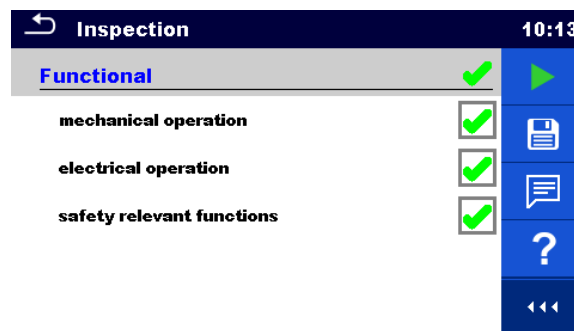

Figure 6.10: Inspection result screen

Options (after inspection is finished)



or

Starts a new inspection.



Saves the result.

A new inspection was selected and started from a Structure object in the structure tree:

- The inspection will be saved under the selected Structure object.

A new inspection was started from the Single test main menu:

- Saving under the last selected Structure object will be offered by default. The user can select another Structure object or create a new

Structure object. By pressing the  key in Memory organizer menu the inspection is saved under selected location.

An empty inspection was selected in structure tree and started:

- The result(s) will be added to the inspection. The inspection will change its status from 'empty' to 'finished'.

An already carried out inspection was selected in structure tree, viewed and then restarted:

- A new measurement will be saved under the selected Structure object.



Adds comment to the measurement. The instrument opens keypad for entering a comment.



Opens help screens. Refer to chapter 6.1.3 *Help screens* for more information.

6.1.2.4 Single test (inspection) memory screen

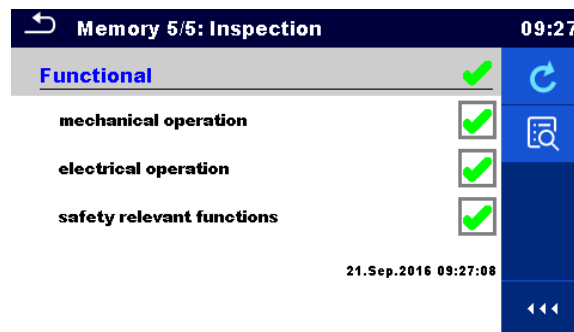

Figure 6.11: Inspection memory screen

Options



Retest
Starts inspection with cleared statuses.



Enters view mode.

6.1.3 Help screens

Help screens contain diagrams for proper connection of the instrument.

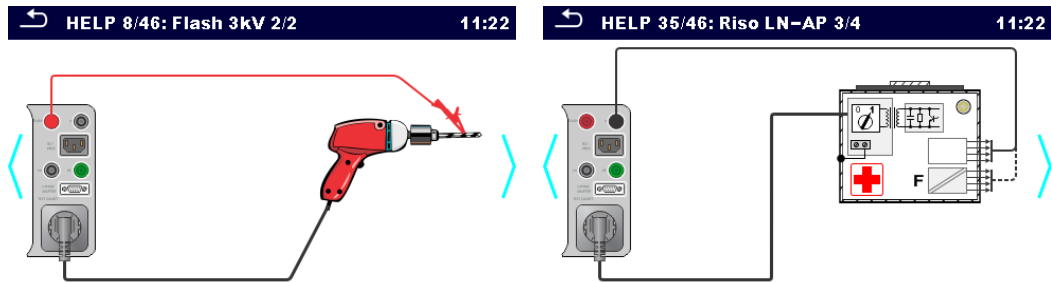
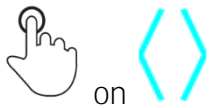

Figure 6.12: Examples of help screens

Options:



Opens help screen.



Goes to previous / next help screen.

6.2 Single test measurements

6.2.1 Visual inspection

Test results / sub-results

Pass, Fail, Checked

Test circuit

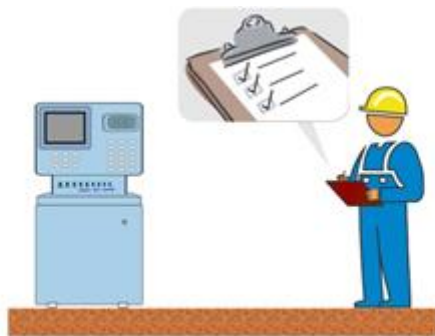

6.2.2 Continuity // Protective earth resistance

Test results / sub-results

R..... Resistance

Test parameters

Output (Continuity)	Output: [P/S – PE, MS_PE – IEC_PE]
Output (Protective earth resistance)	Output: [P/S – PE]
Test current	I out: [0.2 A, 10 A, 25 A]
Duration	Duration: [Off, 2 s ... 180 s]

Test limits

H Limit (R) (Continuity)	H Limit(R): [Off, Custom, 0.01 Ω ... 9 Ω]
Limit (R) (Protective earth resistance)	Limit(R): [Off, Custom, 0.1 Ω ... 0.5 Ω]

Additional options

Calibrate	Calibrate – see Compensation of test lead / IEC test cable resistance .
Limit Calculator	Lim. Calculator see Limit calculator .

Note

- For the test between P/S and PE banana sockets only test current 200 mA is available.

Test circuits

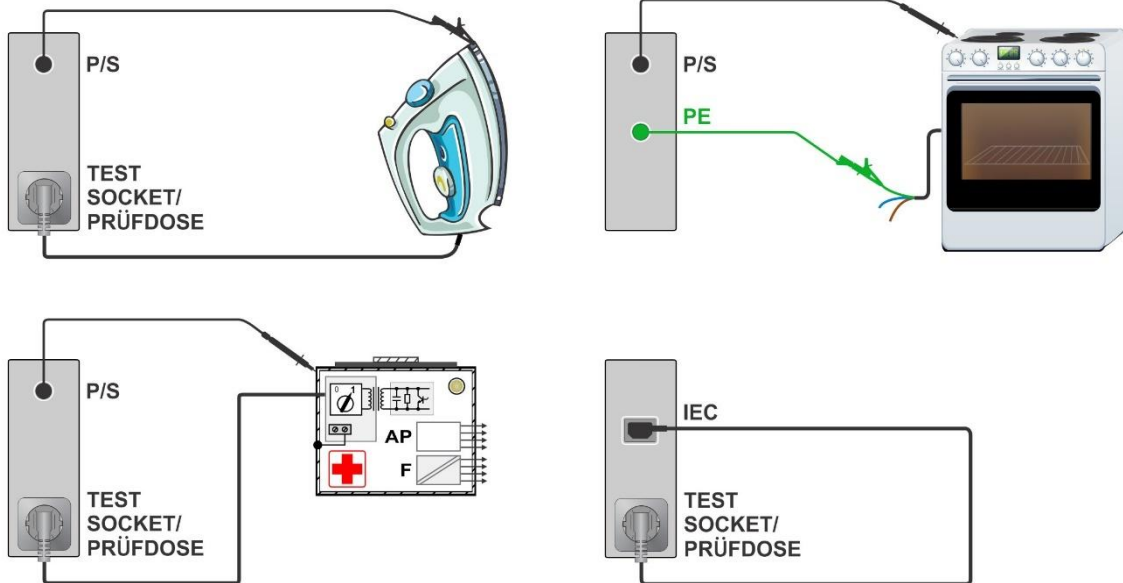

6.2.2.1 Compensation of test lead(s) / IEC test cable resistance

Resistance of test lead(s) and cables can be compensated. Compensation is possible in following functions:

- Continuity (Output = P/S - PE, MS_PE - IEC_PE)
- Protective Earth Resistance (Output = P/S - PE)
- PE conductor (PRCD)

Connection for compensating the resistance of test lead(s) / IEC test cable

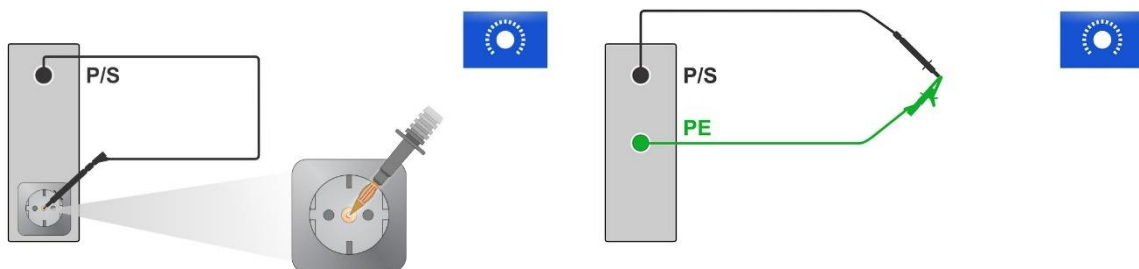

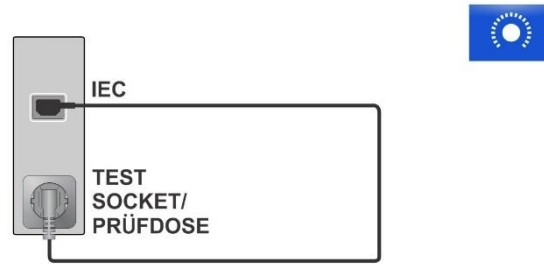

Compensation of test lead(s) / IEC test cable resistance procedure

Select single test and its parameters.

Connect test lead to the instrument between P/S terminal and PE terminal on test socket or short-circuit test leads connected to P/S and PE banana sockets, or connect IEC test cable between IEC connector and test socket.

Calibrate: Compensate test lead(s) / IEC test cable resistance

Symbol  is displayed if the compensation was carried out successfully.

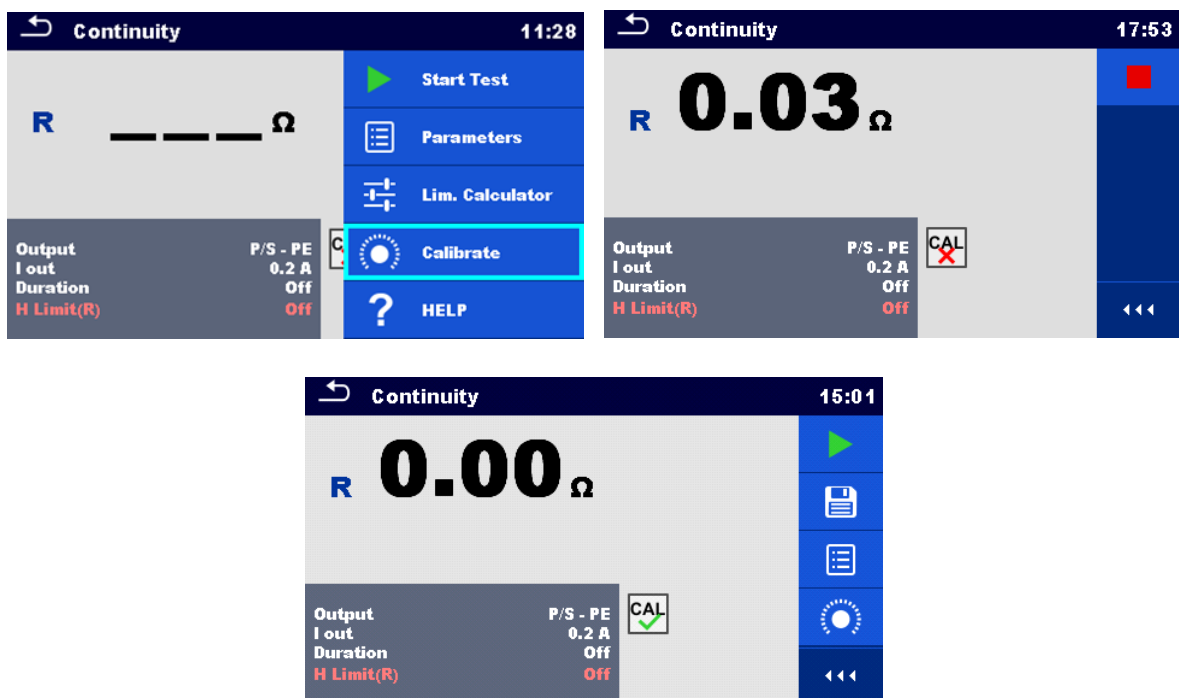

Notes

- The compensation value is correct only for the output (P/S terminal – PE terminal on test socket or P/S terminal – PE terminal) at which the calibration was carried out.
- It is recommended to compensate leads resistance with the same test current as the measurement will be made.

6.2.2.2 Limit calculator

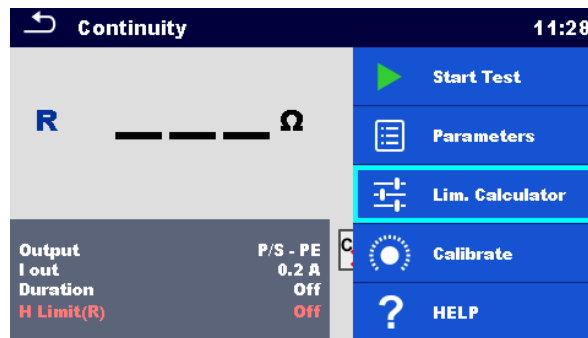

Limit calculator is a tool for determining the resistance high limit.

Open Limit calculator	Lim. Calculator
Define the limit value	Set Limit rule: Length, Cross-section, Custom

Limit rules:

A: EN / CSA $\leq 1.5 \text{ mm}^2$

Resistance limit is set in accordance with the EN 50678 and EN 50699 standards, for cross section areas up to 1.5 mm^2 .

L wire length	R Limit [Ω]
L $\leq 5 \text{ m}$	0.3
5 m < L $\leq 12.5 \text{ m}$	0.4
12.5 m < L $\leq 20 \text{ m}$	0.5
20 m < L $\leq 27.5 \text{ m}$	0.6
27.5 m < L $\leq 35 \text{ m}$	0.7
35 m < L $\leq 42.5 \text{ m}$	0.8
42.5 m < L $\leq 50 \text{ m}$	0.9
50 m < L $\leq 57.5 \text{ m}$	1.0

B: Calculator

Resistance limit is calculated by the formula:

$$R = \rho \frac{L}{A} + 0.1\Omega$$

ρ	Specific resistance of copper $1.68 \times 10^{-8} \Omega\text{m}$
L	Wire length selected from a list (1 m, 2 m, 3 m, ... ,100 m) or custom numeric entry
A	Wire cross section selected from a list (0.50 mm ² , 0.75 mm ² , 1.00 mm ² , 1.50 mm ² , 2.5 mm ² , 4.0 mm ² , 10.0 mm ²) or custom numeric entry

C: NEN 3140*

Resistance limit is derived from table on wire length and wire cross-section basis. Table is based on NEN 3140 standard.

	Wire cross-section [mm ²]			
	1.5	2.5	4	6
L wire length	R Limit [Ω]			
L \leq 2 m	0.22	0.21	0.21	0.21
2 m < L \leq 5 m	0.26	0.24	0.22	0.21
5 m < L \leq 10 m	0.32	0.27	0.24	0.23
10 m < L \leq 15 m	0.38	0.31	0.27	0.24
15 m < L \leq 20 m	0.43	0.34	0.29	0.26
20 m < L \leq 25 m	0.49	0.38	0.31	0.27
25 m < L \leq 30 m	0.55	0.41	0.33	0.29
30 m < L \leq 35 m	0.61	0.45	0.35	0.30
35 m < L \leq 40 m	0.67	0.48	0.38	0.32
40 m < L \leq 45 m	0.73	0.52	0.40	0.33
45 m < L \leq 50 m	0.78	0.55	0.42	0.35

	Wire cross-section [mm ²]		
	10	16	25
L wire length	R Limit [Ω]		
L \leq 2 m	0.20	0.20	0.20
2 m < L \leq 5 m	0.21	0.21	0.20
5 m < L \leq 10 m	0.22	0.21	0.21
10 m < L \leq 15 m	0.23	0.22	0.21
15 m < L \leq 20 m	0.24	0.22	0.21
20 m < L \leq 25 m	0.24	0.23	0.22
25 m < L \leq 30 m	0.25	0.23	0.22
30 m < L \leq 35 m	0.26	0.24	0.22
35 m < L \leq 40 m	0.27	0.24	0.23
40 m < L \leq 45 m	0.28	0.25	0.23
45 m < L \leq 50 m	0.29	0.25	0.24

^{*)} Not applicable in AUS and UK versions.

D: Custom

Resistance limit is directly selected from a list (Off, 0.01 Ω ... 0.09 Ω , 0.1 Ω ... 0.9 Ω , 1 Ω ... 9 Ω) or set via keypad (Custom).

6.2.3 Flash test

Test results / sub-results

I	AC test current
---	-----------------

Test parameters

Output test voltage	U test [1500 V, 3000 V]
---------------------	-------------------------

Duration	Duration [Off, 2 s ... 180 s]
----------	-------------------------------

Test limits

H Limit (I)	Limit(I): [Custom, 0.50 mA ... 2.25 mA]
-------------	---

Test circuits

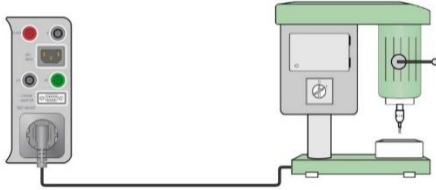

Flash test 1500 V

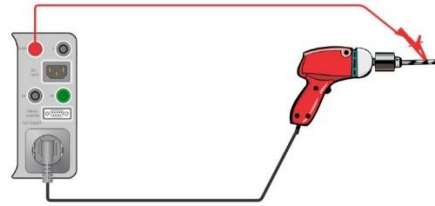

Flash test 3000 V

Note

- Flash test 1500 V is intended for CLASS I appliances.
- Flash test 3000 V is intended for CLASS II appliances.
- If Flash test 3000 V is conducted on CLASS I appliances with unearthed conductive parts, then both tests (3000 V between LN and unearthed conductive part and 1500 V between LN and PE) are tested simultaneously and current through PE is also considered.

6.2.4 Insulation resistance (Riso, Riso-S)

Test results / sub-results

Riso	Insulation resistance
Riso-S	Insulation resistance-S
Um	Test voltage

Test parameters

Type of test	Type [Riso, Riso-S, (Riso, Riso-S)]
Nominal test voltage	Uiso [250 V, 500 V]
Duration	Duration [Off, 2 s ... 180 s]

Test limits

L Limit (Riso)	L Limit (Riso) [Off, Custom, 0.01 M Ω ... 10.0 M Ω]
L Limit (Riso-S)	L Limit (Riso-S) [Off, Custom, 0.1 M Ω ... 10.0 M Ω]

Test circuits

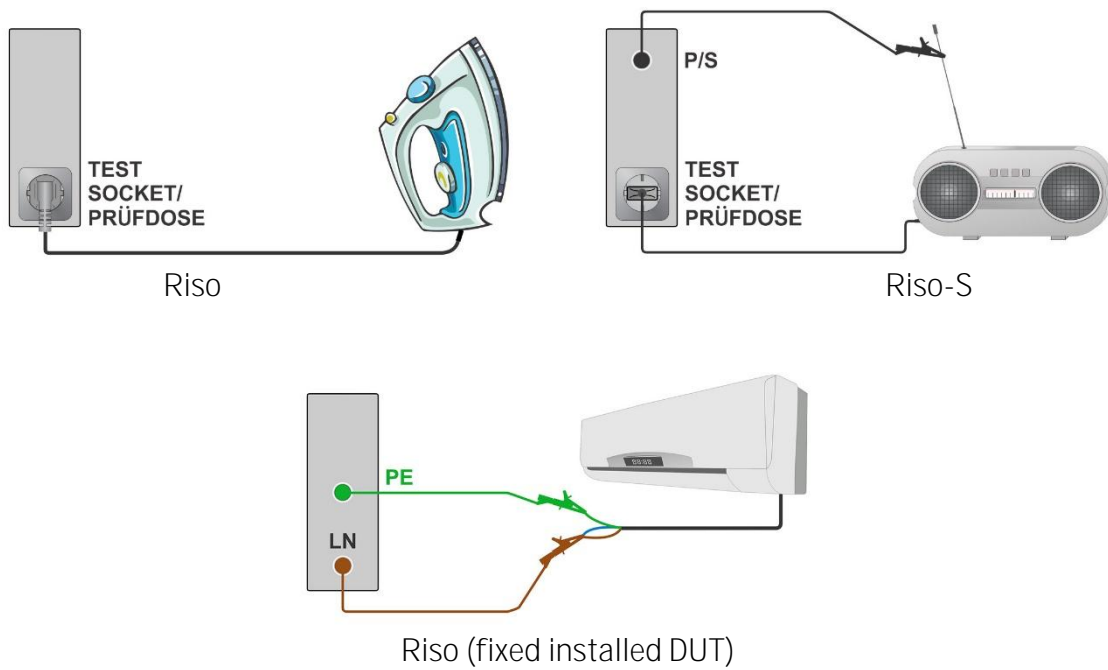

Note

- The current through the P/S probe is also considered in the Riso result.

6.2.5 Sub-leakage (I_{sub} , I_{sub-S})

Test results / sub-results

I_{sub} (+result)	Sub-leakage current Result [TRMS]
I_{sub-S} (+result)	Sub-leakage current-S Result [TRMS]

Test parameters

Type	Type of test [I_{sub} , I_{sub-S} , I_{sub} I_{sub-S}]
Duration	Duration [Off, 2 s ... 180 s]

Test limits

H Limit (I_{sub} TRMS)	H Limit (I_{sub} TRMS) [Off, Custom, 0.25 mA ... 15.0 mA]
H Limit (I_{sub-S} TRMS)	H Limit (I_{sub-S} TRMS) [Off, Custom, 0.25 mA ... 15.0 mA]

Test circuits

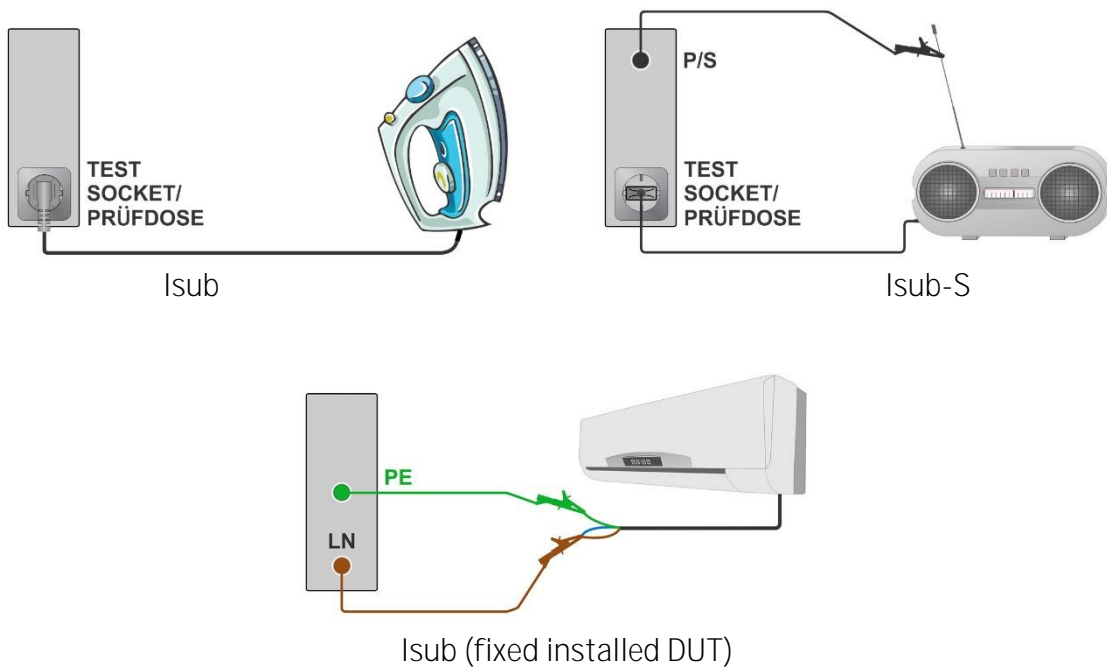

Note

- When P/S probe is connected during the Sub-leakage measurement, then the current through it is also considered.

6.2.6 Differential Leakage

Test results / sub-results

Idiff (+ mains, result)	Diff: Differential Leakage current Mains [nor, rev] ¹ Result [TRMS]
-------------------------	--

p ²	Power
----------------	-------

¹⁾ not shown separately in Result view = Standard

Test parameters

Duration	Duration [Off, 2 s ... 180 s]
Mains polarity ²	[All, Normal, Reversed] Normal: phase voltage is applied to the right output of the mains test socket. Reversed: phase voltage is applied to the left output of the mains test socket. All: tests at both polarities will be carried out.

Delay ²	Delay between the two steps, if Mains polarity = All, [0.1 s ... 5 s]
--------------------	--

Adapter	[No, A 1830] No: Adapter is disabled in measurement A 1830: Adapter is enabled in measurement
---------	---

²) result or parameter not available for measurements with 3-phase adapter A 1830
See *A 1830 Instruction manual* for more information.

Test limit

H Limit (Idiff TRMS) ³	H limit (Idiff, TRMS) [Off, Custom, 0.25 mA ... 15.0 mA]
-----------------------------------	--

³) Result view = All - [nor, rev] are added to Test Limit names. Test limit remains the same.

Test circuit

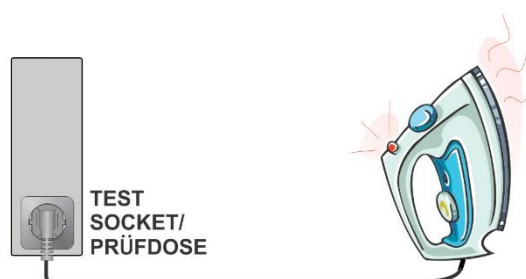

6.2.7 Ipe Leakage

Test results / sub-results

Ipe (+ mains, condition, result)	PE Leakage current Mains [nor, rev] ¹ Condition [NC, sfN] ² Result [TRMS, AC, DC]
----------------------------------	--

p ²	Power
----------------	-------

¹) not shown separately in Result view = Standard

Test parameters

Duration	Duration [Off, 2 s ... 180 s]
----------	-------------------------------

Mains polarity ²	[All, Normal, Reversed] Normal: phase voltage is applied to the right output of the mains test socket. Reversed: phase voltage is applied to the left output of the mains test socket. All: all tests will be carried out.
-----------------------------	---

Condition ²	[All, NC, SFC-N] NC: normal condition
------------------------	--

	SFC-N: single fault, N open All: all tests will be carried out
Delay ²	Delay between the two steps, if Mains polarity = All, [0.1 s ... 5 s]
Adapter	[No, A 1830] No: Adapter is disabled in measurement A 1830: Adapter is enabled in measurement

²⁾ result or parameter not available for measurements with 3-phase adapter A 1830
See A 1830 *Instruction manual* for more information.

Test limits

H Limit (I _{pe} TRMS) ³	H limit (I _{pe} , NC, TRMS) [Off, Custom, 0.25 mA ... 15.0 mA]
H Limit (I _{pe} AC) ³	H limit (I _{pe} , NC, AC) [Off, Custom, 0.50 mA, 5.00 mA]
H Limit (I _{pe} DC) ³	H limit (I _{pe} , NC, DC) [Off, Custom, 2.0 mA, 25 mA]
H Limit (I _{pe} sfN TRMS) ³	H limit (I _{pe} , sfN, TRMS) [Off, Custom, 0.25 mA ... 15.0 mA]
H Limit (I _{pe} sfN AC) ³	H limit (I _{pe} , sfN, AC) [Off, Custom, 0.50 mA, 5.00 mA]
H Limit (I _{pe} sfN DC) ³	H limit (I _{pe} , sfN, DC) [Off, Custom, 2.0 mA, 25 mA]

³⁾ Result view = All - [nor, rev] are added to Test Limit names. Test limit remains the same.

Test circuit

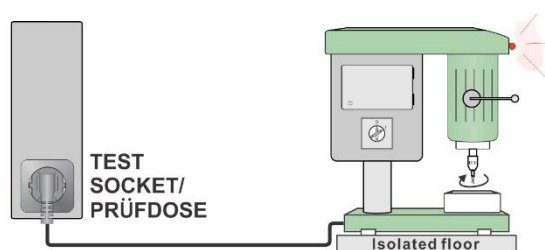

6.2.8 Touch Leakage

Test results / sub-results

I _{to} (+ mains, condition, result)	Touch Leakage current Mains [nor, rev] ¹ Condition [NC, sfN, sfPE] ² Result [TRMS, AC, DC]
P ²	Power

¹⁾ not shown separately in Result view = Standard

Test parameters

Duration	Duration [Off, 2 s ... 180 s]
Mains polarity ²	[All, Normal, Reversed] Normal: phase voltage is applied to the right output of the mains test socket. Reversed: phase voltage is applied to the left output of the mains test socket. All: tests at both polarities will be carried out.
Condition ²	[All, NC, SFC-N, SFC-PE] NC: normal condition SFC-N: single fault, N open SFC-PE: single fault, PE open All: all tests will be carried out
Delay ²	Delay between the two steps, if Mains polarity = All, [0.1 s ... 5 s]
Adapter	[No, A 1830] No: Adapter is disabled in measurement A 1830: Adapter is enabled in measurement

²⁾ result or parameter not available for measurements with 3-phase adapter A 1830
See *A 1830 Instruction manual* for more information.

Test limits

H Limit (Itou TRMS) ³	H limit (Itou, NC, TRMS) [Off, Custom, 0.25 mA ... 15.0 mA]
H Limit (Itou AC) ³	H limit (Itou, NC, AC) [Off, Custom, 0.50 mA, 5.00 mA]
H Limit (Itou DC) ³	H limit (Itou, NC, DC) [Off, Custom, 2.0 mA, 25 mA]
H Limit (Itou sfN TRMS) ³	H limit (Itou, sfN, TRMS) [Off, Custom, 0.25 mA ... 15.0 mA]
H Limit (Itou sfN AC) ³	H limit (Itou, sfN, AC) [Off, Custom, 0.50 mA, 5.00 mA]
H Limit (Itou sfN DC) ³	H limit (Itou, sfN, DC) [Off, Custom, 2.0 mA, 25 mA]
H Limit (Itou sfPE TRMS) ³	H limit (Itou, sfPE, TRMS) [Off, Custom, 0.25 mA ... 15.0 mA]
H Limit (Itou sfPE AC) ³	H limit (Itou, sfPE, AC) [Off, Custom, 0.50 mA, 5.00 mA]
H Limit (Itou sfPE DC) ³	H limit (Itou, sfPE, DC) [Off, Custom, 2.0 mA, 25 mA]

³⁾ Result view = All - [nor, rev] are added to Test Limit names. Test limit remains the same.

Test circuit

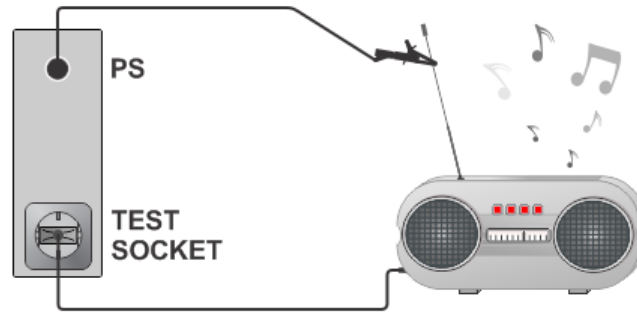

6.2.9 Itouch+Ifloating input

Test results / sub-results

Itou+Ifi (+ result)	Sum of Touch Leakage and Floating Input currents Result [TRMS]
Itou (+ mains, result)	Touch Leakage current Mains [nor, rev] ¹ Result [TRMS]
Ifi (+ result)	Floating Input Leakage current Result [TRMS]
no caption	Actual current measurement (Itou or Ifi) [TRMS]

¹⁾ not shown separately in Result view = Standard

Test parameters

Duration	Duration [Off, 2 s ... 180 s]
Mains polarity	[All, Normal, Reversed] Normal: phase voltage is applied to the right output of the mains test socket. Reversed: phase voltage is applied to the left output of the mains test socket. All: tests at both polarities will be carried out.
Delay	Delay between the two steps, if Mains polarity = All, [0.1 s ... 5 s]
Uinp max	Maximal voltage on floating inputs [Custom, 250 V..1000 V] Note: Value used for calculation of Ifi.

Test limits

H Limit (Itou TRMS) ²	H limit (Itou, NC, TRMS) [Off, Custom, 0.25 mA ... 15.0 mA]
H Limit (Itou+Ifi TRMS)	H limit (Itou+Ifi TRMS) [Off, Custom, 0.25 mA ... 15.0 mA]

²⁾ Result view = All - [nor, rev] are added to Test Limit names. Test limit remains the same.

Test circuits

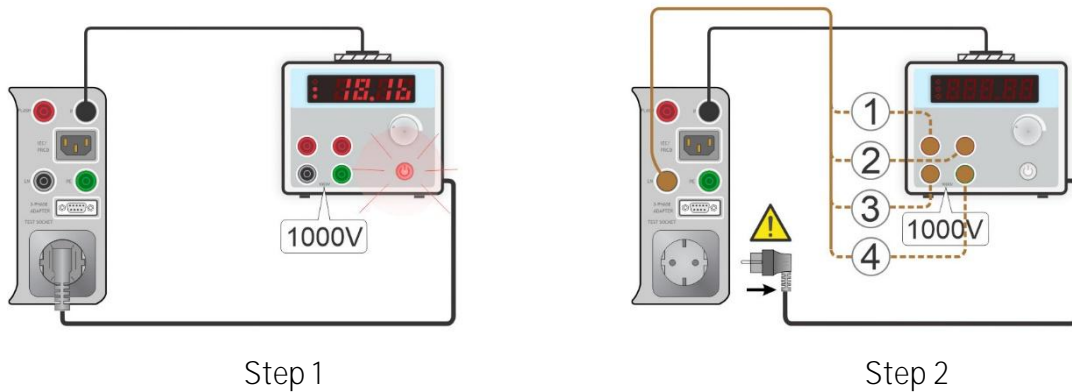

Notes

- The measurement consists of three steps.
Step 1 - I_{tou} is measured.
Step 2 - I_{fi} is measured. If there are more floating inputs, individual inputs can be measured successively and the results are added together.
Step 3 - The end result $I_{tou} + I_{fi}$ is calculated as sum of touch current and I_{fi} (the overall value).
- Worst result of $I_{tou} + I_{fi}$ of normal and reversed polarity is considered, if Mains polarity = All.

Warning

- In Step 2, DUT shall be disconnected from mains test socket in order to avoid unwanted leakage paths through PE. Appropriate message is displayed.

6.2.10 $I_{pe} + I_{floating}$ input

Test results / sub-results

$I_{pe} + I_{fi}$ (+ result)	Sum of PE and Floating Input leakage currents Result [TRMS]
$I_{diff} + I_{fi}$ (+ result)	Sum of Differential and Floating Input leakage currents Result [TRMS]
I_{pe} (+ mains, result)	PE Leakage current Mains [nor, rev] ¹ Result [TRMS]
I_{diff} (+ mains, result)	Differential Leakage current Mains [nor, rev] ¹ Result [TRMS]

lfi (+ result)	Floating Input leakage current Result [TRMS]
no caption	Actual current measurement (I _{pe} , I _{diff} or I _{fi}) [TRMS]
1) not shown separately in Result view = Standard	

Test parameters

Duration	Duration [Off, 2 s ... 180 s]
Mains polarity	[All, Normal, Reversed] Normal: phase voltage is applied to the right output of the mains test socket. Reversed: phase voltage is applied to the left output of the mains test socket. All: tests at both mains polarity will be carried out.
Delay	Delay between the two steps, if Mains polarity = All, [0.1 s ... 5 s]
U _{inp} max	Maximal voltage on floating inputs [Custom, 250 V ... 1000 V] Note: Value used for calculation of I _{fi} .

Test limits

H Limit (I _{pe} TRMS) ²	H limit (I _{pe} , NC, TRMS) [Off, Custom, 0.25 mA ... 15.0 mA]
H Limit (I _{pe} +I _{fi} TRMS)	H limit (I _{pe} +I _{fi} , TRMS) [Off, Custom, 0.25 mA ... 15.0 mA]
H Limit (I _{diff} TRMS) ²	H limit (I _{diff} , TRMS) [Off, Custom, 0.25 mA ... 15.0 mA]
H Limit (I _{diff} +I _{fi} TRMS)	H limit (I _{diff} +I _{fi} , TRMS) [Off, Custom, 0.25 mA ... 15.0 mA]

2) Result view = All - [nor, rev] are added to Test Limit names. Test limit remains the same.

Test circuits

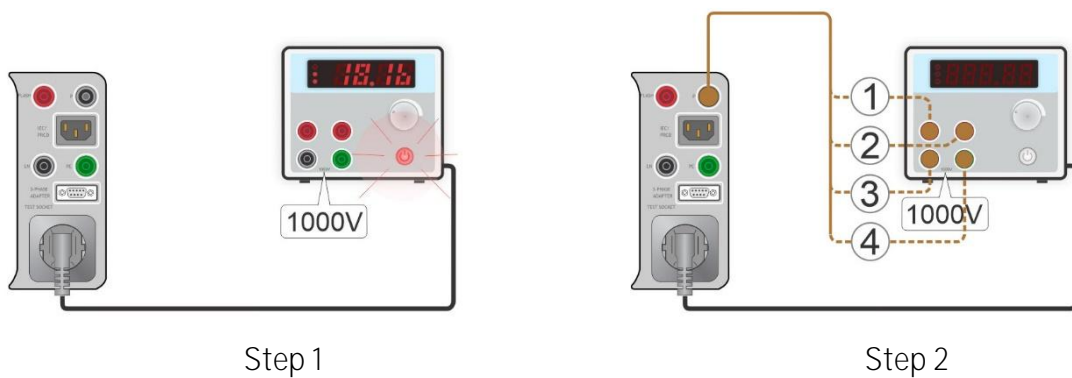

Notes

- The measurement consists of three steps.
Step 1 - I_{pe} or I_{diff} is measured.
Step 2 - I_{fi} is measured. If there are more floating inputs, individual inputs can be measured successively and the results are added together.
Step 3 - The end result $I_{pe} + I_{fi}$ or $I_{diff} + I_{fi}$ is calculated as sum of I_{pe} or I_{diff} current and I_{fi} (the overall value).
- Worst result of $I_{pe} + I_{fi}$ or $I_{diff} + I_{fi}$ of normal and reversed polarity is considered, if Mains polarity = All.

6.2.11 Power

Test results / sub-results

P	Active power
S	Apparent power
Q	Reactive power
PF	Power factor
THDu	Total harmonic distortion – voltage
THDi	Total harmonic distortion – current
Cos Φ	Cosine Φ
I	Load current
U	Voltage

Test parameter

Duration	Duration [Off, 2 s ... 180 s]
----------	-------------------------------

Test limits

H Limit (P)	H limit (P) [Off, Custom, 10 W ... 3.50 kW]
L Limit (P)	L limit (P) [Off, Custom, 10 W ... 3.50 kW]

Test circuit

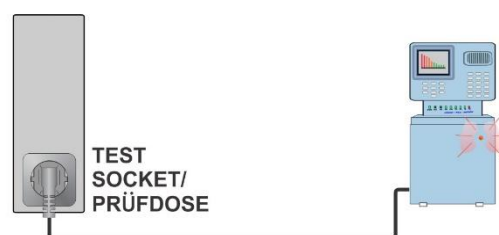

6.2.12 Leak's & Power

Test results / sub-results

Itou (+ mains, condition, result)	Touch Leakage current Mains [nor, rev] ¹⁾ Condition [NC, sfN, sfPE] Result [TRMS, AC, DC]
Idiff TRMS (+ mains)	Diff: Differential Leakage current Mains [nor, rev] ¹⁾ Condition [NC]
P	Active power
S	Apparent power
Q	Reactive power
PF	Power factor
THDu	Total harmonic distortion - voltage
THDi	Total harmonic distortion - current
Cos Φ	Cosine Φ
I	Load current
U	Voltage

¹⁾ not shown separately in Result view = Standard

Test parameters

Duration	Duration [Off, 2 s ... 180 s]
Mains polarity	[All, Normal, Reversed] Normal: phase voltage is applied to the right output of the mains test socket. Reversed: phase voltage is applied to the left output of the mains test socket. All: test with both main polarities will be carried out.
Condition	[All, NC, SFC-N, SFC-PE] NC: normal condition SFC-N: single fault, N open SFC-PE: single fault, PE open All: all tests will be carried out
Delay	Delay between the two steps, if Mains polarity = All, [0.1 s ... 5 s]

Test limits

H Limit (Itou TRMS) ²	H limit (Itou, NC, TRMS) [Off, Custom, 0.25 mA ... 15.0 mA]
H Limit (Itou AC) ²	H limit (Itou, NC, AC) [Off, Custom, 0.50 mA, 5.00 mA]
H Limit (Itou DC) ²	H limit (Itou, NC, DC) [Off, Custom, 2.0 mA, 25 mA]
H Limit (Itou sfN TRMS) ²	H limit (Itou, sfN, TRMS) [Off, Custom, 0.25 mA ... 15.0 mA]
H Limit (Itou sfN AC) ²	H limit (Itou, sfN, AC) [Off, Custom, 0.50 mA, 5.00 mA]
H Limit (Itou sfN DC) ²	H limit (Itou, sfN, DC) [Off, Custom, 2.0 mA, 25 mA]
H Limit (Itou sfPE TRMS) ²	H limit (Itou, sfPE, TRMS) [Off, Custom, 0.25 mA ... 15.0 mA]
H Limit (Itou sfPE AC) ²	H limit (Itou, sfPE, AC) [Off, Custom, 0.50 mA, 5.00 mA]
H Limit (Itou sfPE DC) ²	H limit (Itou, sfPE, DC) [Off, Custom, 2.0 mA, 25 mA]
H Limit (Idiff TRMS) ²	H limit (Idiff, TRMS) [Off, Custom, 0.25 mA ... 15.0 mA]
H Limit (P)	H limit (P) [Off, Custom, 10 W ... 3.50 kW]
L Limit (P)	L limit (P) [Off, Custom, 10 W ... 3.50 kW]

²⁾ Result view = All - [nor, rev] are added to Test Limit names. Test limit remains the same.

Test circuits

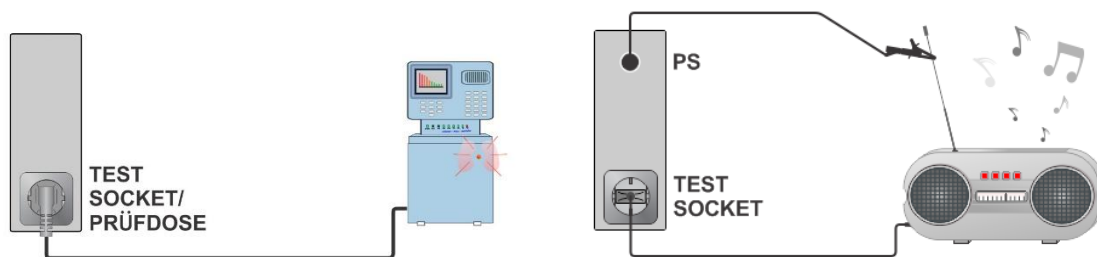

6.2.13 PRCD test

Test results / sub-results

t ΔN	trip-out time
t $I_{\Delta N} \times 1, (+)$	trip-out time ($I_{\Delta} = I_{\Delta N}, (+)$ positive polarity)
t $I_{\Delta N} \times 1, (-)$	trip-out time ($I_{\Delta} = I_{\Delta N}, (-)$ negative polarity)
t $I_{\Delta N} \times 5, (+)$	trip-out time ($I_{\Delta} = 5 \times I_{\Delta N}, (+)$ positive polarity)
t $I_{\Delta N} \times 5, (-)$	trip-out time ($I_{\Delta} = 5 \times I_{\Delta N}, (-)$ negative polarity)
t $I_{\Delta N} \times 0.5, (+)$	trip-out time ($I_{\Delta} = \frac{1}{2} \times I_{\Delta N}, (+)$ positive polarity)
t $I_{\Delta N} \times 0.5, (-)$	trip-out time ($I_{\Delta} = \frac{1}{2} \times I_{\Delta N}, (-)$ negative polarity)
I_{Δ}	trip-out current
$I_{\Delta} (+)$	trip-out current ((+) positive polarity)
$I_{\Delta} (-)$	trip-out current ((-) negative polarity)

Test parameters

RCD Type	Type [AC, A, B, B+, F]
Nominal current	$I_{\Delta N}$ [10 mA, 15 mA, 30 mA, 100 mA ¹ , 300 mA ¹]
Test mode	Mode [single, auto]
Multiplication factor $I_{\Delta N}$	Multiplier [0.5, 1, 5]
Starting polarity in single mode	Phase [+ , - , (+,-)]
Design type	Design [2 pole, 3 pole, K/Di (varistor), S (3 pole), S+]
PRCD Standard	PRCD standard [General, AS/NZS 3017]

¹⁾ in combination with 3 – phase adapters (A 1322 or A 1422)

Test limits

Test limits for Pass / Fail statuses are set automatically, depending on set parameters.

Test circuit



6.2.14 RCD test

Test results / sub-results

t ΔN	trip out time
t $I_{\Delta N} \times 1, (+)$	trip-out time ($I_{\Delta}=I_{\Delta N}, (+)$ positive polarity)
t $I_{\Delta N} \times 1, (-)$	trip-out time ($I_{\Delta}=I_{\Delta N}, (-)$ negative polarity)
t $I_{\Delta N} \times 5, (+)$	trip-out time ($I_{\Delta}=5 \times I_{\Delta N}, (+)$ positive polarity)
t $I_{\Delta N} \times 5, (-)$	trip-out time ($I_{\Delta}=5 \times I_{\Delta N}, (-)$ negative polarity)
t $I_{\Delta N} \times 0.5, (+)$	trip-out time ($I_{\Delta}=\frac{1}{2} \times I_{\Delta N}, (+)$ positive polarity)
t $I_{\Delta N} \times 0.5, (-)$	trip-out time ($I_{\Delta}=\frac{1}{2} \times I_{\Delta N}, (-)$ negative polarity)
I_{Δ}	trip-out current
$I_{\Delta} (+)$	trip-out current ((+) positive polarity)
$I_{\Delta} (-)$	trip-out current ((-) negative polarity)
Uc	Contact voltage

Test parameters

RCD type	Type [AC, A, B, B+, F]
Nominal current	$I_{\Delta N}$ [10 mA, 15 mA, 30 mA]
Test mode	Mode [single, auto]
Multiplication factor $I_{\Delta N}$	Multiplier [0.5, 1, 5]
Phase Starting polarity in single mode	Phase [+ , - , (+,-)]
RCD Standard	RCD standard [EN 61008 / EN 61009, AS/NZS 3017]
Random phase	Random phase [No, Yes] ¹

¹ only if AS/NZS 3017 RCD Standard is selected

Test limit

Uc	Contact voltage limit [Custom, 25 V, 50 V]
-----------	--

Test limit for Pass / Fail statuses is set automatically, depending on set parameters.

Test circuit

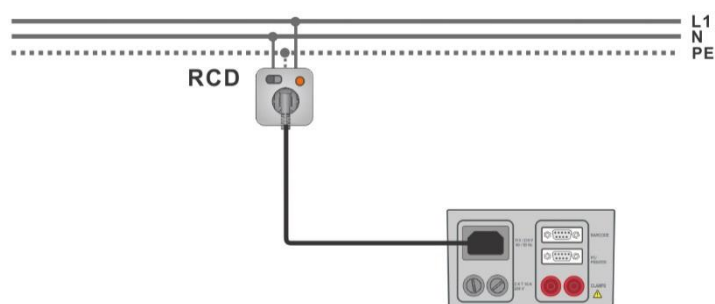

6.2.15 PE conductor (PRCD)

Test results / sub-results

R..... Resistance

Result..... Indication that the protection of the varistor in PE connection works properly

Test parameters

Type of PRCD	Design [2 pole, 3 pole, K/Di (varistor), S (3 pole), S+]
Duration	Duration [Off, 2 s ... 180 s]
Nominal current	I Δ N [10 mA, 15 mA, 30 mA, 100 mA, 300 mA]
Nominal current (K/Di varistor)	I Δ N [10 mA, 30 mA]

Test limits

H Limit (R)	H Limit(R) [Off, Custom, 0.01 Ω ... 9 Ω]
-------------	---

Specific options



Calibrate - Compensation of test lead / IEC test cable resistance.
Refer to chapter *Compensation of test lead / IEC test cable resistance* for procedure details.



Lim. Calculator - PE_conductor(PRCD) resistance H Limit(R) calculator.
Refer to chapter *Limit Calculator* for details.

Test circuit



Notes

- Mains voltage is applied to the PRCD during the test.
- The instrument uses different test methods in regard to the set PRCD type. For 2 pole, 3 pole, S (3 pole) and S+ PRCDs the resistance of PE conductor is measured. For K/Di PRCDs the operation of the varistor in the PE connection is tested.
- **L and N conductors are not allowed to be crossed in this test. Reconnect the PRCD's plug if necessary.**
- PE resistance of IEC plug adapter can be compensated. See chapter *Compensation of test lead / IEC test cable resistance* for details.

6.2.16 Open conductor (PRCD)

In this test the instrument disconnects individual conductors on the supply side and the response of the PRCD is checked.

Test results / sub-results

L open	Result for open L conductor [Pass, Fail]
N open	Result for open N conductor [Pass, Fail]
PE open	Result for open PE conductor [Pass, Fail]

Test parameters / limit

Conductor, opened by the instrument	Open [L, N, PE, (auto L,N), (auto L,N,PE)]
Type of PRCD	Design [2 pole, 3 pole, K/Di (varistor), S (3 pole), S+]

Test circuit



6.2.17 PRCD PE probe test

Test results / sub-results

Result	Indication of the test [Pass, Fail]
--------	-------------------------------------

Test parameters / limits

Test mode	Test [manual, auto]
Type of PRCD	Design [2 pole, 3 pole, K/Di (varistor), S (3 pole), S+]

Test circuits

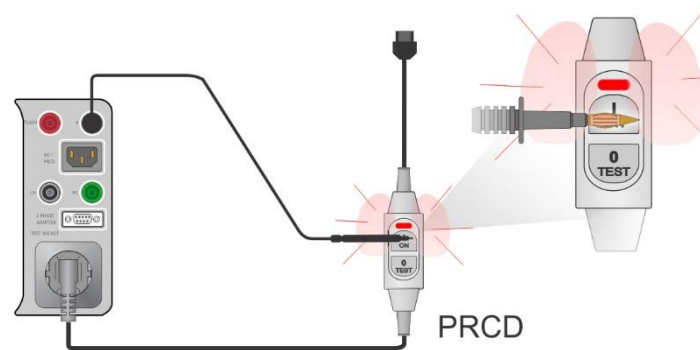

Test = manual

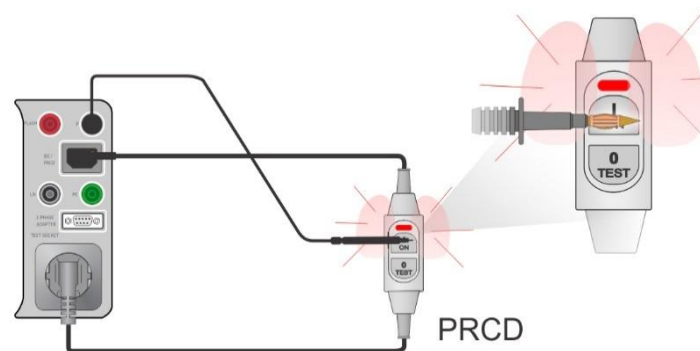

Test = auto

Notes

- A safe but high voltage is applied to the test lead during the test. Do not touch the exposed tip at the end of the test lead. Risk of not dangerous but unpleasant electric shock!
- The test is intended for PRCDs with built in detection of hazardous voltage on PE.

6.2.18 Polarity

Test results / sub-results

Result	Indication of the test [Pass, Description of the fault]
Test parameters / limits	
Test mode	Mode [normal, active]
Test status	Status [On, Off] (disable test status within Auto Sequence® for K/Di PRCD)
L and N cross	Cross of phase and neutral wire [not allowed, allowed ¹⁾]
Wiring map ²⁾	Wiring map [standard, L1-L2-L3-N-PE, L2-L3-L1-N-PE, L3-L1-L2-N-PE, L3-L2-L1-N-PE, L2-L1-L3-N-PE, L1-L3-L2-N-PE, L1-L2-L3-PE, L2-L3-L1-PE, L3-L1-L2-PE, L3-L2-L1-PE, L2-L1-L3-PE, L1-L3-L2-PE, L1-N-PE, L2-N-PE, L3-N-PE, Rotation 123 (N), Rotation 321 (N), Rotation 123, Rotation 321]

¹⁾ Not applicable in AUS and UK versions.

²⁾ Wiring map parameter replaces LN cross parameter if active polarity mode is selected and Metrel 3-phase adapter (A 1322 or A 1422) is connected.

Test circuits



Mode = normal

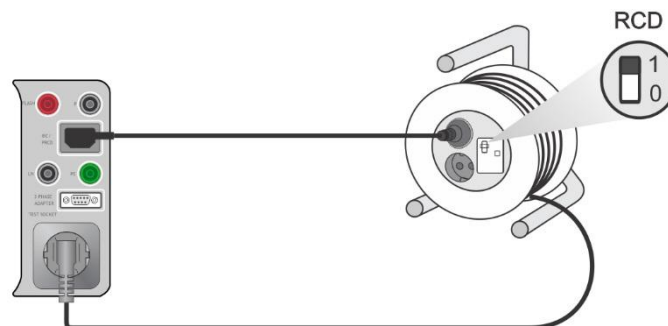

Mode = active

Note

- Active polarity test is intended for testing cords equipped with (P)RCD or mains operated switches.

6.2.19 Clamp current

Test results / sub-results

I	Current
---	---------

Test parameters

Indication of the type of current measured	Test [Differential leakage, PE leakage, Current]
Duration	Duration [Off, 2 s ... 180 s]
Current clamp model	Ch1 clamp type [A1579]

Test limits

H Limit (I)	Limit(I, Idiff, Ipe) [Off, Custom, 0.25 mA ... 15.0 mA]
H Limit (Idiff)	
H Limit (Ipe)	

Test circuit

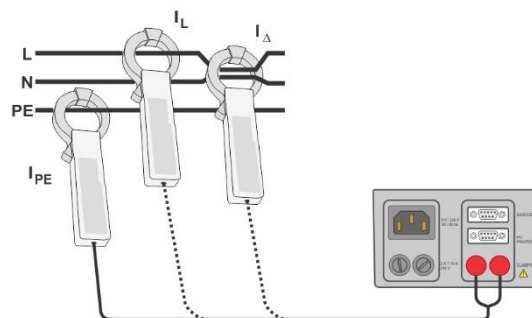

Note

- The frequency range of this measurement is limited. This measurement function cannot be used for measuring leakage currents of appliances that are able to generate leakage currents with frequencies above 10 kHz or above the specified frequency range of the clamp.

6.2.20 Insulation resistance – Riso (welding equipment)

Test results / sub-results

Riso	Insulation resistance
Um	Test voltage

Test parameters

Test type	Test [LN-W, W-PE, LN-PE, LN (Class II) – P/S]
Duration	Duration [Off, 2 s ... 180 s]
Nominal test voltage	Uiso [500 V]dc

Test limit

L Limit (Riso)	Limit(Riso) [Off, Custom, 2.5 M Ω , 5.0 M Ω]
----------------	---

Test circuit

For more information refer to chapter *Measurements according to IEC/ EN 60974-4* – Insulation resistance in 3-phase adapter user manual.

Note

- This test is carried out with METREL 3-phase adapter A 1422.

6.2.21 Welding Circuit Leakage – I leak (W-PE)

Test results / sub-results

Iw	Leakage current
----	-----------------

Test parameters

Duration	Duration [Off, 2 s ... 180 s]
Change status	Change [YES, NO] YES: The instrument measures leakage current in two sequential steps with delay* in between. The phase voltage is firstly applied to the right live output of the mains test socket and secondly to the left live output of the mains test socket. NO: The phase voltage is applied only to the right live output of the mains test socket.

Delay time	Delay [0.2 s ... 5 s]
------------	-----------------------

Test limit	
------------	--

High Limit (Iw)	Limit(Iw) [Off, Custom, 3.50 mA ... 10.00 mA]
-----------------	--

Test circuit

For more information refer to chapter *Measurements according to IEC/ EN 60974-4* – Insulation resistance in 3-phase adapter user manual.

Note

- This test is carried out with METREL 3-phase adapter A 1422.

6.2.22 Protective conductor current

Test results / sub-results

Idiff	Protective conductor current
-------	------------------------------

Test parameters

Duration	Duration [Off, 2 s ... 180 s]
----------	-------------------------------

Change status	Change [YES, NO] YES: The instrument measures leakage current in two sequential steps with delay* in between. The phase voltage is firstly applied to the right live output of the mains test socket and secondly to the left live output of the mains test socket. NO: The phase voltage is applied only to the right live output of the mains test socket.
---------------	--

Delay time	Delay [0.2 s ... 5 s]
------------	-----------------------

Test limit	
------------	--

H Limit (Idiff)	H Limit(Idiff) [Off, Custom, 0.25 mA ... 15.0 mA]
-----------------	---

Test circuit

For more information refer to chapter *Measurements according to IEC/ EN 60974-4* – Insulation resistance in 3-phase adapter user manual.

Notes

- This test is carried out with METREL 3-phase adapter A 1422.
- The differential current measurement principle is used for this test.

6.2.23 No-load voltage

Test results / sub-results

Urms	maximum no-load rms value
Up	maximum no-load peak value

Test parameters

Voltage type on welding output	W-output [a.c., d.c.]
Rated no-load voltage	Rated U_0 no-load voltage [Custom, 20 V ... 99 V, -]

Test limits

Limit (a.c. rms)	Limit (Urms) [Off, 48 V, 80 V, 100 V]
Limit (a.c. peak)	Limit H(Up) [Off, 68 V, 113 V, 141 V]
Limit (d.c. peak)	Limit H(Up) [Off, 113 V, 141 V]
Limit	Limit (Up) [$U_{Op} \pm 15\%$]

Test circuit

For more information refer to chapter *Measurements according to IEC/ EN 60974-4* – Insulation resistance in 3-phase adapter user manual.

Note

- This test is carried out with METREL 3-phase adapter A 1422.

6.2.24 Insulation resistance – Riso (medical equipment)

Test results / sub-results

Riso	Insulation resistance
Um	Test voltage

Test parameters

Test	Test_Riso_ME [LN-PE, LN-P/S, LN-AP, PE-AP]
Duration	Duration [Off, 2 s ... 180 s]
Nominal test voltage	Uiso [250 V, 500 V]

Test limit

L Limit (Riso)	Limit(Riso) [Off, Custom, 2 M Ω ... 70 M Ω]
----------------	--

Test circuits

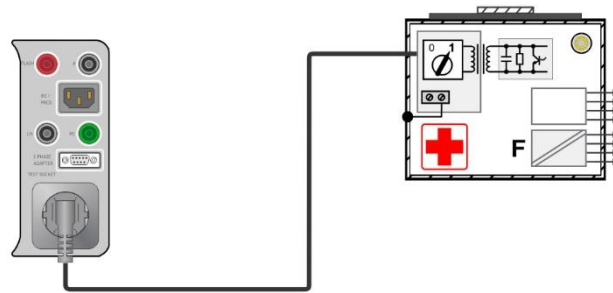

Insulation resistance - LN-PE

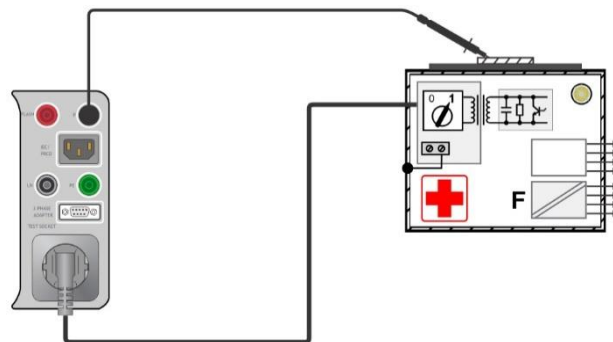

Insulation resistance - LN-P/S

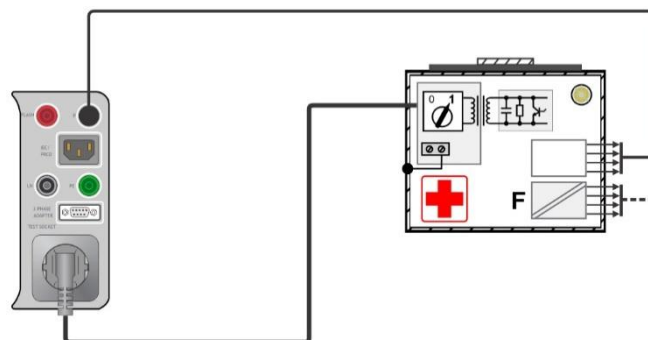

Insulation resistance - LN-AP

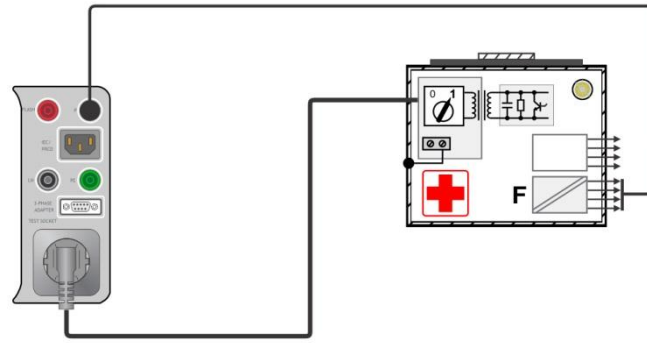

Insulation resistance - PE-AP

6.2.25 Equipment Leakage

Test results / sub-results

leq (+ mains, result)	Equipment Leakage current Mains [nor, rev] ¹ Result [TRMS, AC ² , DC ²]
P	Power (only in Direct and Differential test mode)
U _{lpe}	Measured voltage between phase and earth

¹) not shown separately in Result view = Standard

²) only in Direct test method

Test parameters

Duration	Duration [Off, 2 s ... 180 s]
Method	Test method [Alternative, Direct, Differential]
Mains polarity	[All, Normal, Reversed] Normal: phase voltage is applied to the right output of the mains test socket. Reversed: phase voltage is applied to the left output of the mains test socket. All: tests at both mains polarity will be carried out.
Delay	Delay between the two steps, if Mains polarity = All, [0.1 s ... 5 s]
Unom	Nominal line to earth voltage whose value corresponds to the nominal mains voltage Unom [100 V ... 240 V]

Test limits

H Limit (leq TRMS) - Alternative method	Limit (leq TRMS) [Off, Custom, 100 μ A, 500 μ A, 1000 μ A]
H Limit (leq TRMS) ³ - Direct and Differential method	Limit (leq TRMS) [Off, Custom, 100 μ A, 500 μ A]

³) Result view = All - [nor, rev] are added to Test Limit names. Test limit remains the same.

Test circuits

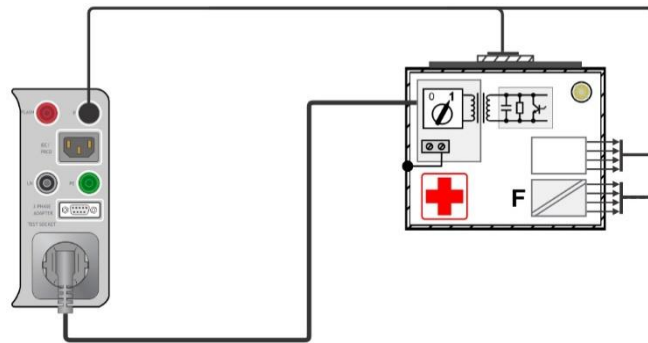

Equipment Leakage (alternative) on Class I ME

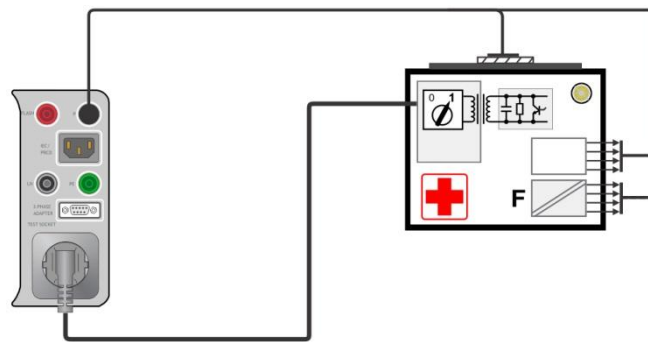

Equipment Leakage (alternative) on Class II ME

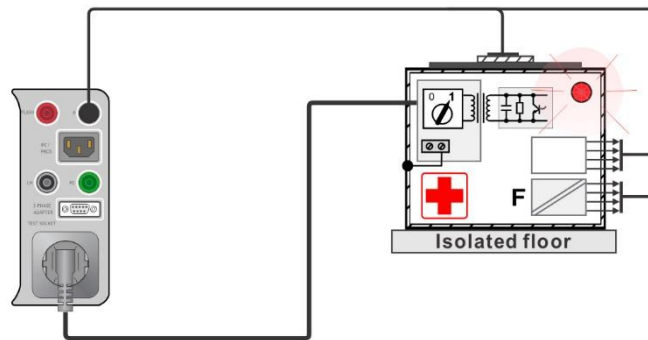

Equipment Leakage (direct) on Class I

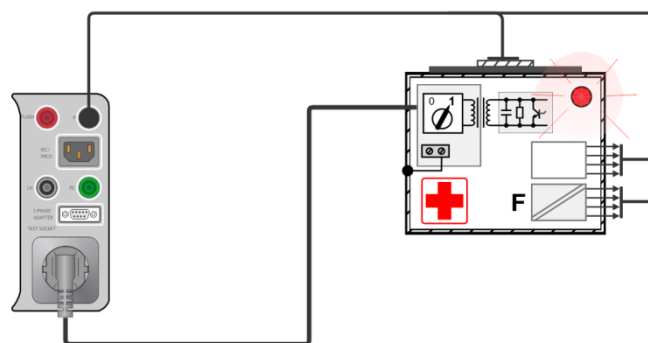

Equipment Leakage (differential) on Class I ME

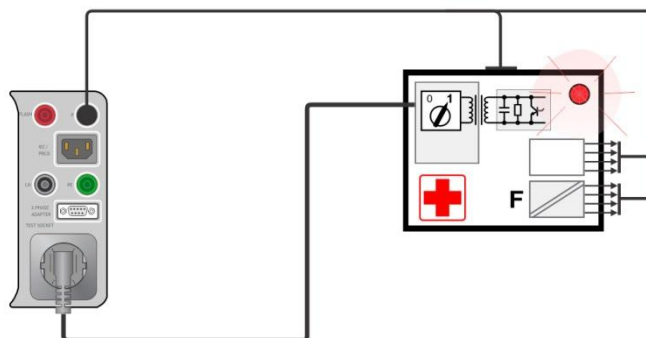

Equipment Leakage (direct, differential) on Class II ME

6.2.26 Applied Part Leakage

Test results / sub-results

lap (+ mains, Vext, result)	Applied Part Leakage current Mains voltage [nor, rev] ¹ Vext on AP [nor, rev] ¹ Result [TRMS]
P	Power
Uap	Measured voltage on applied part

¹⁾ not shown separately in Result view = Standard

Test parameters

Duration	Duration [Off, 2 s ... 180 s]
Method	Test method [Alternative, Direct]
Mains polarity	[All, Normal, Reversed] Normal: phase voltage is applied to the right output of the mains test socket. Reversed: phase voltage is applied to the left output of the mains test socket. All: tests at both mains polarities will be carried out.
Delay	Delay between the two steps, if Mains polarity = All, [0.1 s ... 5 s]
Vext AP	[All, Normal, Reversed] Normal: Vext on AP has same phase as mains voltage. Reversed: Vext on AP has opposite phase as mains voltage. All: all tests will be carried out.
Unom	Nominal line to earth voltage whose value corresponds to the nominal mains voltage Unom [100 V ... 240 V]

Test limit

H Limit (lap TRMS)² Limit (lap TRMS) [Off, Custom, 50 μ A, 100 μ A, 5000 μ A]
 - Alternative and Direct method

²⁾ Result view = All - [nor, rev] are added to Test Limit names. Test limit remains the same.

Test circuits

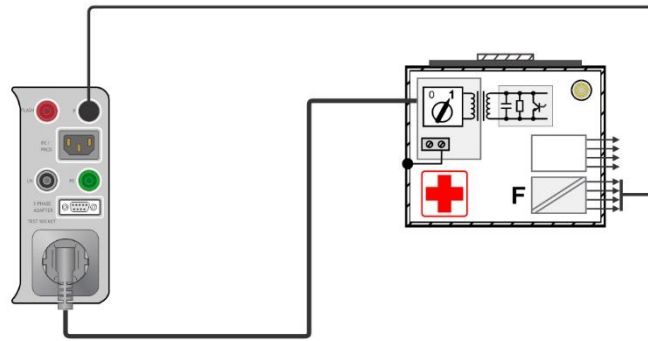

Applied part leakage (alternative) on Class I ME

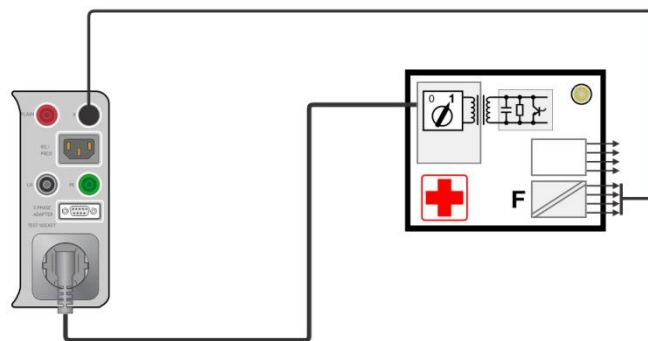

Applied part leakage (alternative) on Class II ME

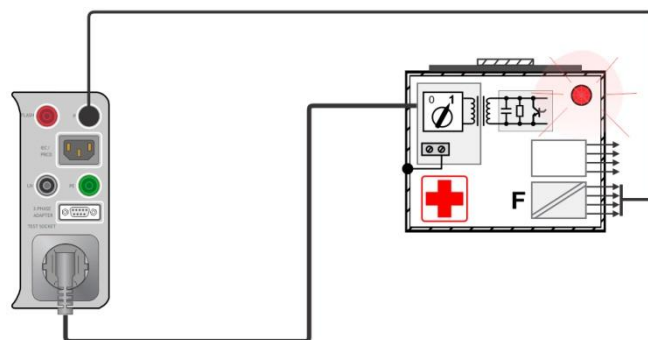

Applied part leakage (direct) on Class I ME

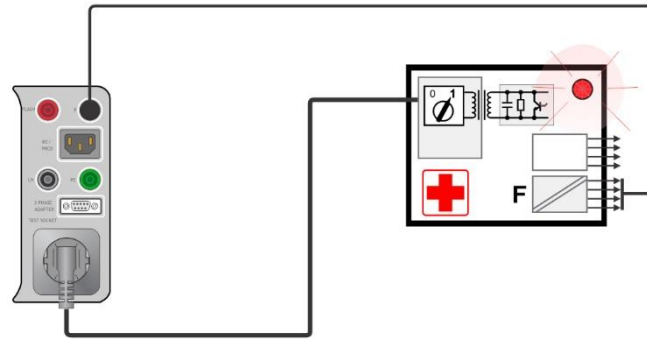

Applied part leakage (direct) on Class II ME

6.2.27 Touch Current (medical equipment)

Test results / sub-results

Itou (+ mains, condition, result)	Touch current Mains [nor, rev] ¹ Result [TRMS, AC, DC]
P	Power
U _{lpe}	Measured voltage between phase and earth

¹⁾ not shown separately in Result view = Standard

Test parameters

Duration	Duration [Off, 2 s ... 180 s]
Mains polarity	[All, Normal, Reversed] Normal: phase voltage is applied to the right output of the mains test socket. Reversed: phase voltage is applied to the left output of the mains test socket. All: tests at both mains polarities will be carried out.
Condition	[All, NC, SFC-N, SFC-PE] NC: normal condition SFC-N: single fault, N open SFC-PE: single fault, PE open All: all tests will be carried out
Delay	Delay between the two steps, if Mains polarity = All, [0.1 s ... 5 s]
Unom	Nominal line to earth voltage whose value corresponds to the nominal mains voltage Unom [100 V ... 240 V]

Test limits

H Limit (Itou TRMS) ²	Limit (Itou, NC, TRMS) [Off, Custom, 100 µA]
H Limit (Itou sfN TRMS) ²	Limit (Itou, sfN, TRMS) [Off, Custom, 500 µA]

H Limit (Itou sfPE TRMS)² Limit (Itou, sfPE, TRMS) [Off, Custom, 500 μ A]

²⁾ Result view = All - [nor, rev] are added to Test Limit names. Test limit remains the same.

Test circuit

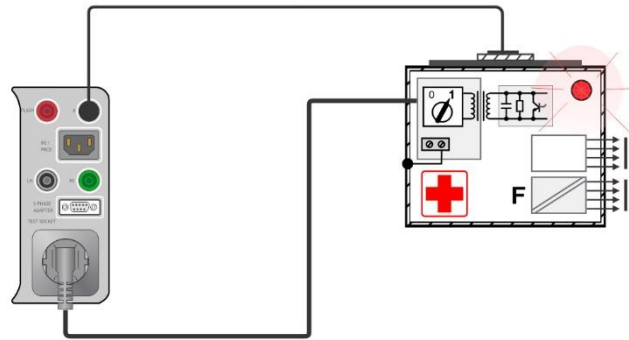

6.2.28 Patient Leakage Current

Test results / sub-results

Ip (+ mains, condition, result)	Patient leakage current Mains [nor, rev] ¹ Result [TRMS, AC, DC]
P	Power
U _{lpe}	Measured voltage between phase and earth

¹⁾ not shown separately in Result view = Standard

Test parameters

Duration	Duration [Off, 2 s ... 180 s]
Mains polarity	[All, Normal, Reversed] Normal: phase voltage is applied to the right output of the mains test socket. Reversed: phase voltage is applied to the left output of the mains test socket. All: tests at both mains polarities will be carried out.
Condition	[All, NC, SFC-N, SFC-PE] NC: normal condition SFC-N: single fault, N open SFC-PE: single fault, PE open All: all tests will be carried out
Delay	Delay between the two steps, if Mains polarity = All, [0.1 s ... 5 s]

Unom	Nominal line to earth voltage whose value corresponds to the nominal mains voltage Unom [100 V ... 240 V]
------	---

Test limits

H Limit (Ip TRMS) ²	Limit (Ip NC, TRMS) [Off, Custom, 10 µA, 100 µA]
H Limit (Ip AC) ²	Limit (Ip NC, AC) [Off, Custom, 10 µA, 100 µA]
H Limit (Ip DC) ²	Limit (Ip NC, DC) [Off, Custom, 10 µA]
H Limit (Ip sfN TRMS) ²	Limit (Ip sfN, TRMS) [Off, Custom, 50 µA, 500 µA]
H Limit (Ip sfN AC) ²	Limit (Ip sfN, AC) [Off, Custom, 50 µA, 500 µA]
H Limit (Ip sfN DC) ²	Limit (Ip sfN, DC) [Off, Custom, 50 µA]
H Limit (Ip sfPE TRMS) ²	Limit (Ip sfPE, TRMS) [Off, Custom, 50 µA, 500 µA]
H Limit (Ip sfPE AC) ²	Limit (Ip sfPE, AC) [Off, Custom, 50 µA, 500 µA]
H Limit (Ip sfPE DC) ²	Limit (Ip sfPE, DC) [Off, Custom, 50 µA]

²⁾ Result view = All - [nor, rev] are added to Test Limit names. Test limit remains the same.

Test circuit

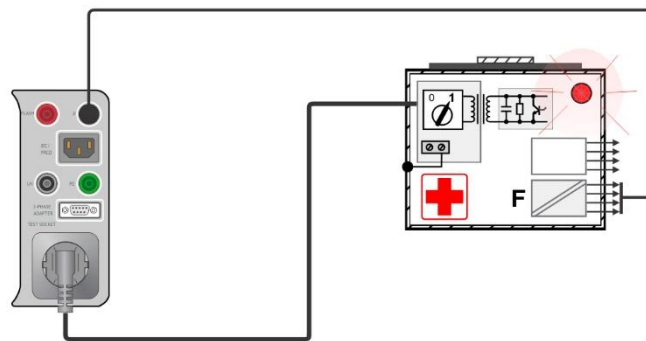

6.2.29 SELV/PELV Voltage

Test results / sub-results

U (+ mains, condition, result)	Voltage Mains [nor, rev] ¹ Result [TRMS, AC, DC]
--------------------------------	---

¹⁾ not shown separately in Result view = Standard

Test parameters

Duration	Duration [Off, 2 s ... 180 s]
Mains	[On, Off] On: mains voltage is applied to the mains test socket Off: no mains voltage on mains test socket

Mains polarity	[All, Normal, Reversed] Normal: phase voltage is applied to the right output of the mains test socket Reversed: phase voltage is applied to the left output of the mains test socket All: tests at both mains polarities will be carried out
Condition	[All, NC, SFC-N, SFC-PE] NC: normal condition SFC-N: single fault, N open SFC-PE: single fault, PE open All: all tests will be carried out
Delay	Delay between the two steps, if Mains polarity = All, [0.1 s ... 5 s]

Test limits

H Limit (U TRMS) ²	Limit (U, NC, TRMS) [Off, Custom, 50 V, 60 V]
H Limit (U AC) ²	Limit (U, NC, AC) [Off, Custom, 30 V, 50 V]
H Limit (U DC) ²	Limit (U, NC, DC) [Off, Custom, 60 V, 120 V]
H Limit (U sfN TRMS) ²	Limit (U, sfN, TRMS) [Off, Custom, 50 V, 60 V]
H Limit (U sfN AC) ²	Limit (U, sfN, AC) [Off, Custom, 30 V, 50 V]
H Limit (U sfN DC) ²	Limit (U, sfN, DC) [Off, Custom, 60 V, 120 V]
H Limit (U sfPE TRMS) ²	Limit (U, sfPE, TRMS) [Off, Custom, 50 V, 60 V]
H Limit (U sfPE AC) ²	Limit (U, sfPE, AC) [Off, Custom, 30 V, 50 V]
H Limit (U sfPE DC) ²	Limit (U, sfPE, DC) [Off, Custom, 60 V, 120 V]

²⁾ Result view = All - [nor, rev] are added to Test Limit names. Test limit remains the same.

Test circuits

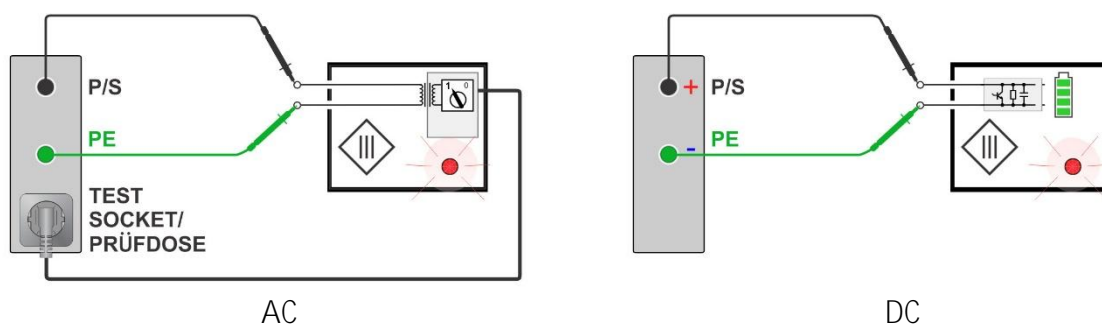

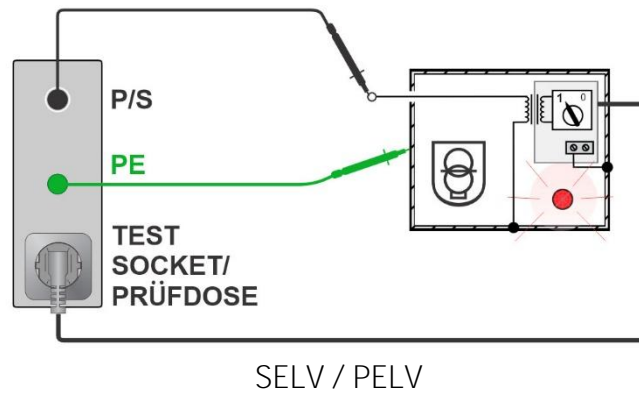

Note

- Voltmeter is floating against PE.

6.2.30 EVSE Diagnostic Test (A 1632)

Test results / sub-results

CP+	Maximal value of CP (control pilot) signal
CP-	Minimal value of CP (control pilot) signal
Duty C.	Duty cycle of CP (control pilot) signal
Freq	Frequency of CP (control pilot) signal
levse	Charging current available by charging cable / EVSE
U1N	Voltage UL1-N on the output of charging cable / EVSE
U2N	Voltage UL2-N on the output of charging cable / EVSE
U3N	Voltage UL3-N on the output of charging cable / EVSE
Field	1.2.3 - correct connection - CW rotation sequence 3.2.1 - invalid connection - CCW rotation sequence
toff	Disconnection time of charging cable / EVSE
State	System state

Test parameters

Test	[EV simulator, Monitor, Errors] EV simulator: simulation of electrical vehicle Monitor: monitoring of EVSE - EV interconnection and signalling Errors: simulation of CP errors
Toff	Simulated CP errors

	[C->E1, C->E2, C->E3, D->E1, D->E2, D->E3]
Simulator CP	CP (control pilot) state setting [nc, A, B, C, D]
Simulator PP	PP (proximity pilot) state setting [nc, 13 A, 20 A, 32 A, 63 A, 80 A]
Duration	Duration [Off, 2 s ... 180 s]
Control	Analyser control [Remote (Bluetooth), Manual (A 1632)]

Test circuit



Notes

- Refer to A 1632 eMobility Analyser Instruction manual for more information
- Refer to application note *Guide to OmegaPAT/GT XA* for more information
- Follow instructions in Metrel Auto Sequences® for charging cables

6.2.31 EV-RCD

Test results / sub-results

t ΔN	trip out time
t IΔN (+)	trip-out time at (+) positive polarity
t IΔN (-)	trip-out time at (-) negative polarity
I ΔN	trip-out current
I IΔN (+)	trip-out current at (+) positive polarity
I IΔN (-)	trip-out current at (-) negative polarity

Test parameters

Test	[t-trip, I-trip] t-trip: trip out time
------	---

	I-trip: trip out current
Test method	[Internal, External] Internal: Charging cable is plugged into mains test socket External: Charging cable is plugged into A 1632 adapter
Test current	Shape of test current [a.c., Pulse d.c.(A), Smooth d.c.] a.c: sinusoidal Pulse d.c. (A): pulsed DC current (half wave) Smooth d.c: smooth DC
$I\Delta N$	Nominal test current [10 mA, 15 mA, 30 mA], [6 mA]
$x I\Delta N$	Multiplication factor [0.5, 1, 2, 5], [0.5, 1, 10]
Phase	Starting polarity of test current [+ , - , (+,-)]
Design	In-cable control and protection device [IC-CPD]
EV-RCD standard	Test standard [IEC 62752]

Test circuits

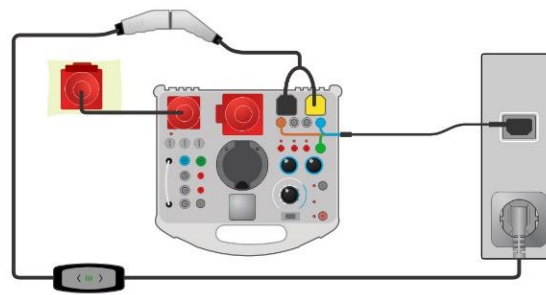

Test method = internal

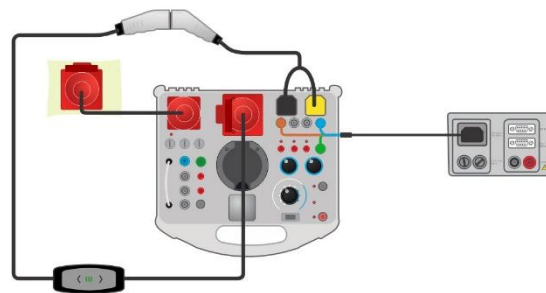

Test method = external

Notes

- Refer to *A 1632 eMobility Analyser Instruction manual* for more information.
- Refer to *A 1532XA eMobility Adapter Instruction manual* for more information.
- Refer to *A 1832 eMobility Adapter Instruction manual* for more information.
- Refer to application note *Guide to OmegaPAT/GT XA* for more information.
- Follow instructions in *Metrel Auto Sequences®* for charging cables.

6.2.32 PE conductor (EV RCD)

Test result / sub-result

R..... Resistance

Test parameters

Type of EV RCD	Design [IC CPD]
Duration	Duration [Off, 2 s ... 180 s]
Test current	I test [standard, low] Standard: I test = 0,2 A Low: I test = 5 mA

Test limit

H Limit (R)	H Limit(R) [Off, Custom, 0.01 Ω ... 9 Ω]
-------------	---

Specific options



Calibrate - Compensation of IEC plug adapter resistance.

Refer to chapter *Compensation of IEC plug adapter resistance* for procedure details.

Lim. Calculator – PE_conductor(PRCD) resistance H Limit(R) calculator.

Refer to chapter *Limit Calculator* for details.

Test circuit

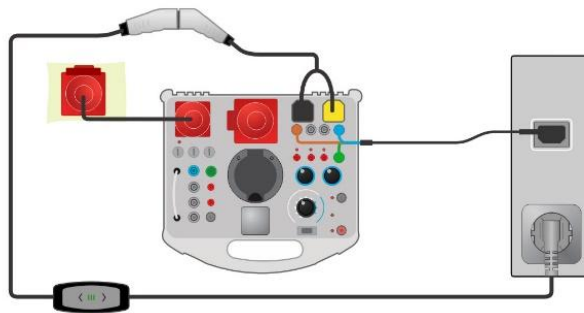

Notes

- PE resistance of IEC plug adapter can be compensated. See chapter *Compensation of IEC plug adapter resistance* for details.

6.2.32.1 Compensation of IEC plug adapter resistance

Resistance of IEC plug adapter can be compensated in PE conductor (EV RCD) test function:

Connection for compensating the resistance of IEC plug adapter

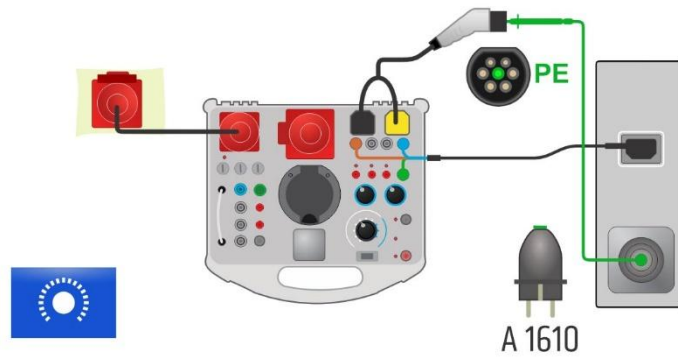

Compensation of IEC plug adapter resistance procedure

Select PE conductor (EV RCD) single test and its parameters.

Connect test instrument and A 1632 eMobility Analyser according to figure above. Connect test lead between test instrument socket PE (using A 1610 Continuity test adapter) and PE pin of A 1634 plug, connected to A 1632 eMobility Analyser.

Calibrate: Compensate IEC plug adapter resistance

Symbol  is displayed if the compensation was carried out successfully.

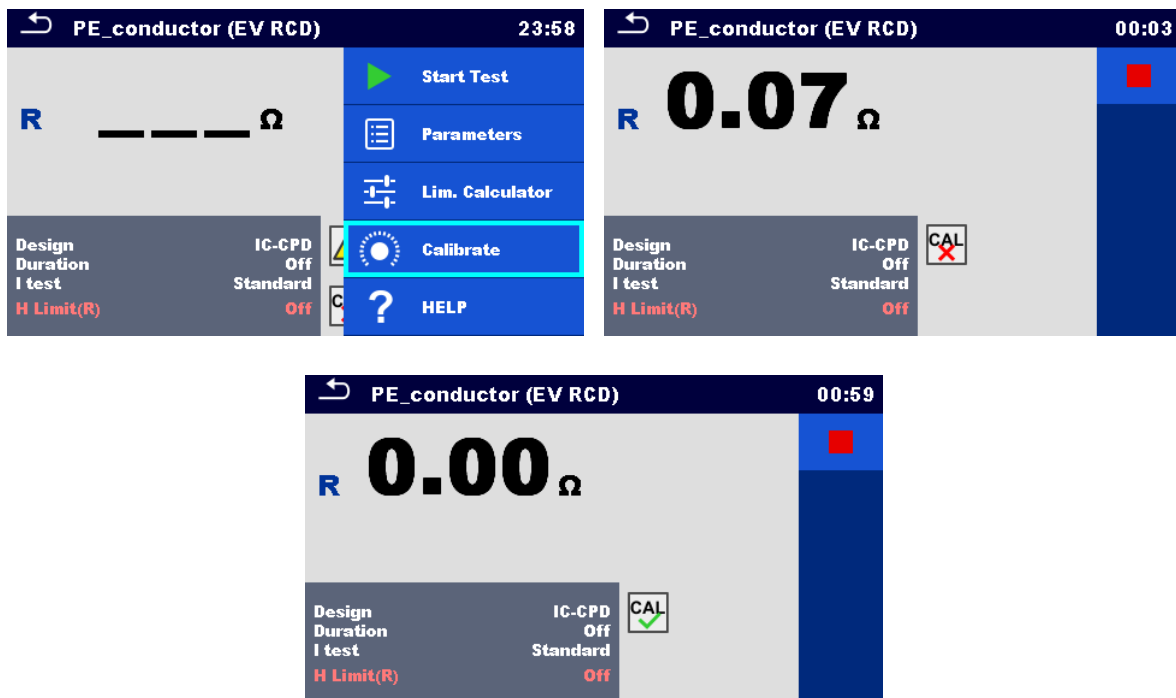

Notes

- It is recommended to compensate leads resistance with the same test current as the measurement will be made.

6.2.33 Functional test

Test results / sub-results

Pass, Fail, Checked

Specific option



Power is applied to the mains test socket to power up the tested equipment during a functional inspection. The instrument displays and starts the Power measurement, refer to *Chapter 6.2.11 Power*

Test circuit

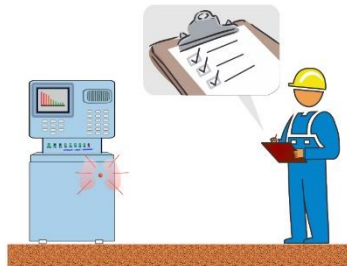

7 Auto Sequences®

Pre-programmed sequences of measurements can be carried out in Auto Sequences® menu. The sequence of measurements, their parameters and flow of the sequence can be programmed. The results of an Auto sequence® can be stored in the memory together with all related information.

Auto Sequences® can be pre-programmed on PC with the Metrel ES Manager software and uploaded to the instrument. On the instrument parameters and limits of individual single test in the Auto Sequence® can be changed / set.





7.1 Selection of Auto Sequences®

The Auto Sequence® list from Auto Sequence® groups menu should be selected first. Refer to chapter 4.13 *Auto Sequence® groups* for more details.

7.1.1 Selecting an active Auto Sequence® group in Auto Sequences® menu

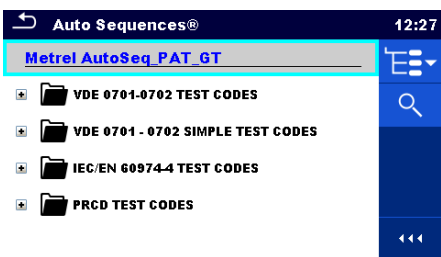
Auto Sequences® and Auto Sequence® group menus are interconnected so an active Auto Sequence® group can be selected also in the Auto Sequences® menu.

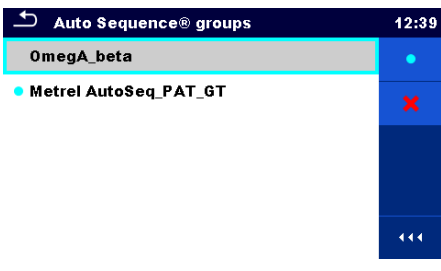
Procedure

- | | | |
|---|---|--|
| ① |  | Tap on the active Auto Sequence® group header in Auto Sequences® Menu. |
| ② |  | Opens a list of Auto Sequence® groups in Control panel. |
| ③ |  | Selects desired Auto Sequence® group from a list of groups. |
| ④ |  | Confirms a new selection. |

⑤

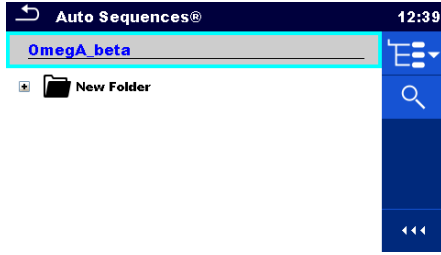

New Auto Sequence® group is selected and all Auto Sequences® within that group are displayed on the screen.

7.1.2 Searching in Auto Sequences® menu

In Auto Sequence® menu it is possible to search for Auto Sequences® on base of their Name or Short code.

Procedure

①

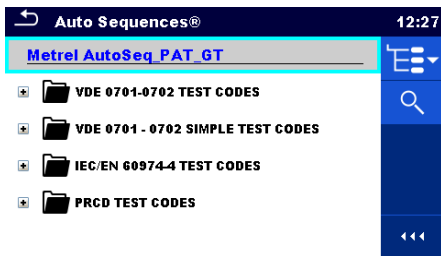

Search function is available from the active Auto Sequence® group header line.

②



Select Search in control panel to open Search setup menu.

③

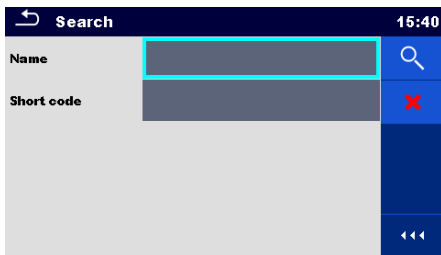

The parameters that can be searched for are displayed in the Search setup menu.

③a



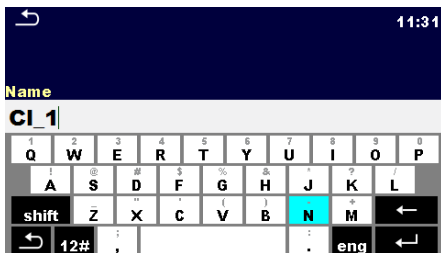

The parameters that can be searched for, are displayed in the Search setup menu.



The search can be narrowed by entering a text in the Name and Short code fields.

Strings can be entered by using the on-screen keyboard.

③b		Clear filters	Clears all filters. Sets filters to default value.
④		Search	Searches through the active Auto Sequence® group according to the set filters. The results are shown in the Search results screen presented on <i>Figure 7.1</i> and <i>Figure 7.2</i> .

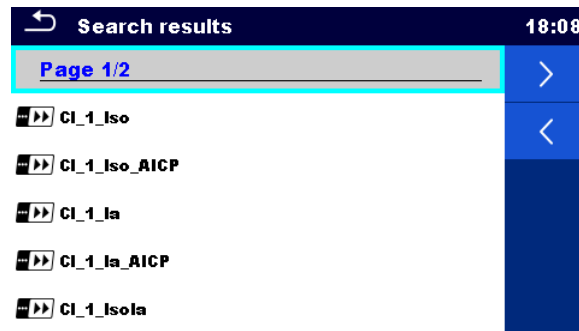

Figure 7.1: Search results screen – Page view

Options:

	Next page.
	Previous page.

Note:

Search result page consist of up to 50 results.

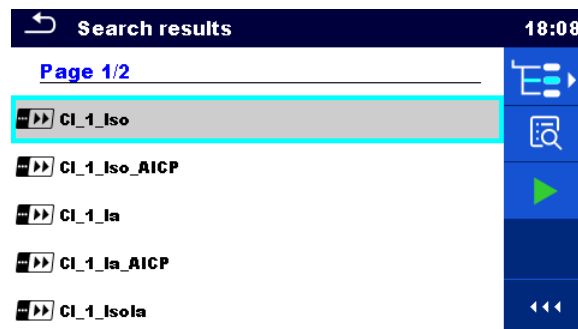



Figure 7.2: Search results screen with Auto Sequences® selected

Options:

	Goes to location in Auto Sequences® menu.
---	---



Goes to Auto Sequence® view menu.



Starts the selected Auto Sequence®.

7.1.3 Organization of Auto Sequences® in Auto Sequences® menu

The Auto Sequences® to be carried out can be selected from the Main Auto Sequences® menu. This menu can be organized in a structural manner with folders, sub-folders and Auto Sequences®. Auto Sequence® in the structure can be the original Auto Sequence® or a shortcut to the original Auto Sequence®.

Auto Sequences® marked as shortcuts and the original auto Sequences® are coupled. Changing of parameters or limits in any of the coupled Auto Sequences® will influence on the original Auto Sequence® and all its shortcuts.

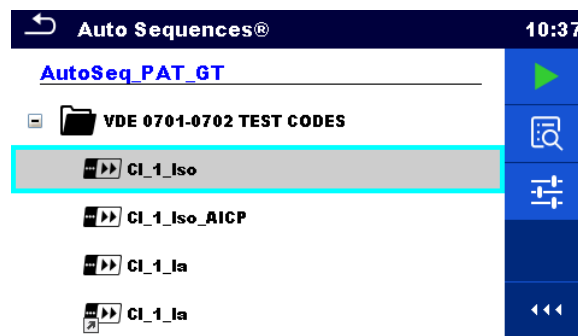
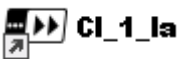

Figure 7.3: Examples of organized Auto Sequences® in main Auto Sequences® menu

Options:



The original Auto Sequence®.



A shortcut to the original Auto Sequence®.



Starts the selected Auto Sequence®.

The instrument immediately starts the Auto sequence®.



Enters menu for more detail view of selected Auto sequence®.

This option should also be used if the parameters / limits of the selected Auto Sequence® have to be changed. Refer to chapter 7.2.1 *Auto Sequence® view menu* for more information.



Enters Auto Sequence® Configurator menu.

See chapter 7.2.1.3 *Auto Sequence® Configurator menu* for details.

7.2 Organization of an Auto Sequence®

An Auto Sequence® is divided into three phases:

- Before starting the first test, the Auto Sequence® view menu is shown (unless it was started directly from the Main Auto Sequences® menu). Parameters and limits of individual measurements can be set in this menu.
- During the execution phase of an Auto Sequence®, pre-programmed single tests are carried out. The sequence of single tests is controlled by pre-programmed flow commands.
- After the test sequence is finished the Auto Sequence® result menu is shown. Details of individual tests can be viewed and the results can be saved to Memory organizer.

7.2.1 Auto Sequence® view menu

In the Auto Sequence® view menu, the header and the single tests of selected Auto Sequence® are displayed. The header contains Name, Short code and description of the Auto Sequence®. Before starting the Auto Sequence®, test parameters / limits of individual measurements can be changed.

7.2.1.1 Auto Sequence® view menu (Header is selected)

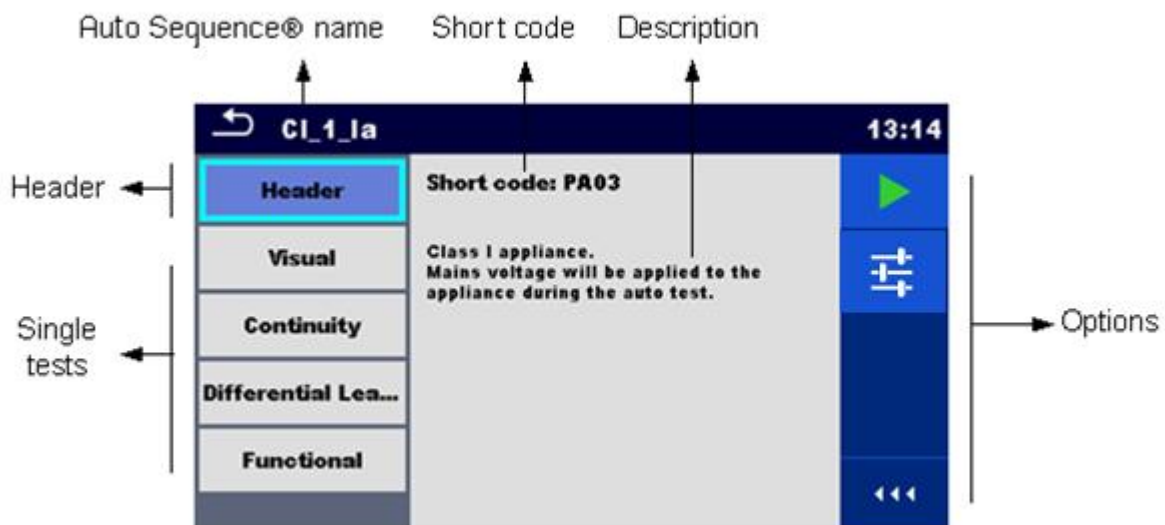

Figure 7.4: Auto Sequence® view menu – Header selected

Options:



Starts the Auto Sequence®.



Enters Auto Sequence® Configurator menu.

See chapter 7.2.1.3 *Auto Sequence® Configurator menu* for details.

7.2.1.2 Auto Sequence® view menu (measurement is selected)

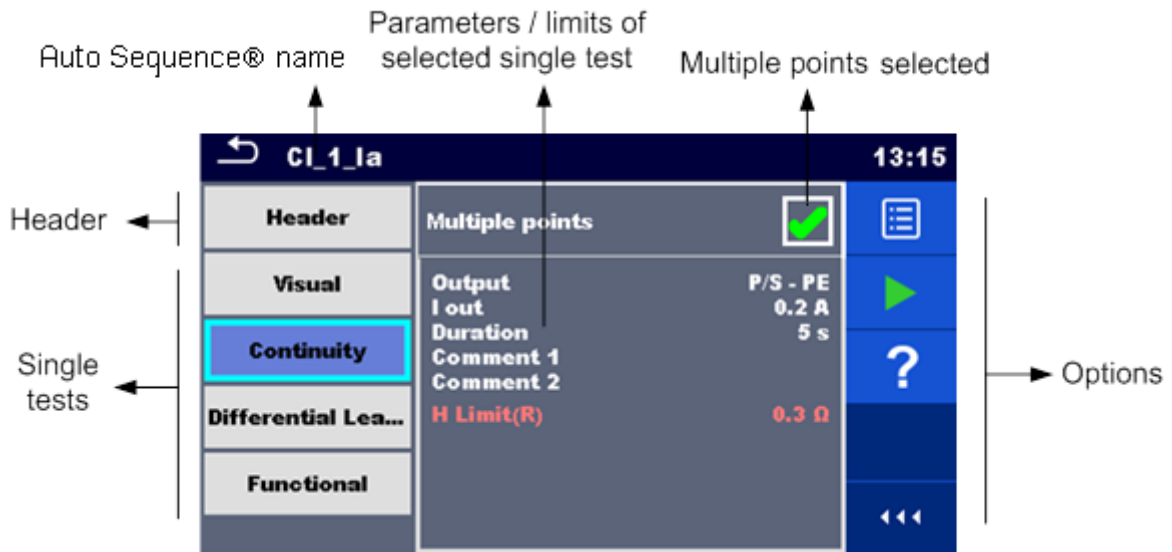

Figure 7.5: Auto Sequence® view menu – measurement selected

Options:



Selects single test.



Opens menu for changing parameters and limits of selected measurements.



Refer to chapter *Setting parameters and limits of single tests* for more information how to change measurement parameters and limits.



Starts the Auto Sequence®.



Compensates test leads resistance in selected test function (if applicable). Refer to chapter *Compensation of test lead(s) / IEC test cable resistance* for more information.



Opens help screens. Refer to chapter *6.1.3 Help screens* for more information.



Selects Multiple points.



Sets operation mode for multiple points. For more information see chapter *Managing multiple points*.



7.2.1.3 Auto Sequence® Configurator menu

Auto Sequence® Configurator menu options are active only when single tests within selected Auto sequence® contain configurable limits and / or parameters. They can be changed to suit requirements of current object under test before Auto sequence® execution. Original settings are overwritten for intended Auto sequence® execution only.

Select  Configurator option from Auto sequence® Main screen or View screen to open Configurator menu presented on *Figure 7.6.* below.

Available settings are organized in groups, each group starts with concerned Single test name. Limit Calculator is referred to Continuity or PE conductor (PRCD) functions. Refer to Single test description chapter for details of parameters and limits setting / calculation.

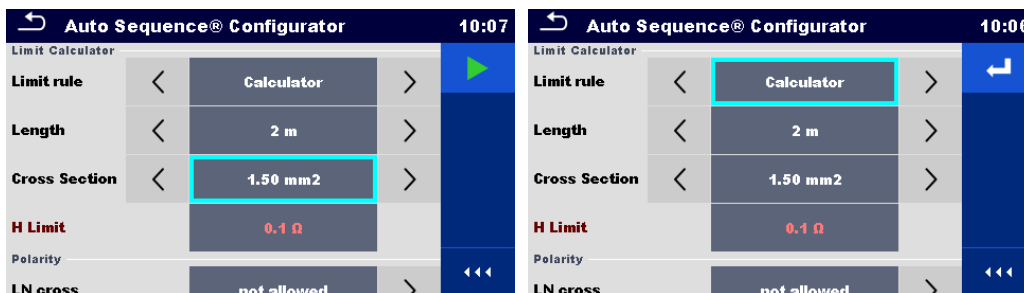

Figure 7.6: Auto Sequence® Configurator menu – opened from Auto Sequence® Main menu on the left, on the right opened from Auto Sequence® view menu

Options:



Starts the Auto Sequence® from Configurator menu. Option is available, if configurator was opened from Auto Sequence® Main menu. New configuration is automatically applied to all related single tests.



Confirms limits and parameters setting and returns to view menu. Option is available, if configurator was opened from Auto Sequence® view menu. Start the Auto Sequence® from view menu with confirmed configuration.

7.2.1.4 Indication of Loops



The attached 'x3' at the end of single test name indicates that a loop of single tests is programmed. This means that the marked single test will be carried out as many times as the **number behind the 'x'** indicates. It is possible to exit the loop before, at the end of each individual measurement.

7.2.1.5 Managing multiple points

If the device under test has more than one test point for an individual single test and the selected Auto Sequence® predicts only one test point (one single test) it is possible to change the Auto Sequence® appropriately. Single tests with enabled Multiple points ticker will be executed in a continuous loop. It is possible to exit the loop anytime at the end of each individual measurement.

The Multiple points setting is valid only for the actual Auto Sequence®. If the user often tests appliances with more than one test points it is recommended to program a special Auto Sequence® with pre-programmed loops.

7.2.2 Step by step execution of Auto Sequences®

While the Auto Sequence® is running, it is controlled by pre-programmed flow commands. Examples of actions controlled by flow commands are:

- pauses during the Auto Sequence®
- buzzer Pass / Fail sound after the tests
- pre-set data off appliances
- expert mode for Inspections
- skip non-safety notifications
- etc.

The actual list of flow commands is available in chapter *E.5 Description of flow commands*.

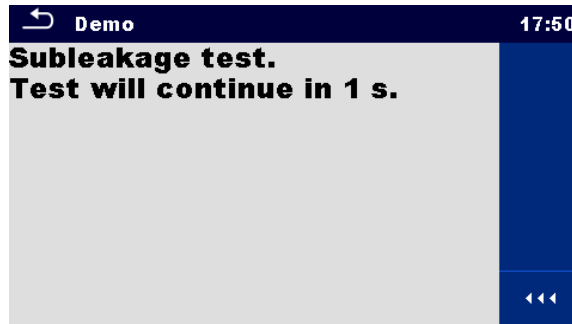

Figure 7.7: Auto Sequence® – Example of a pause with message

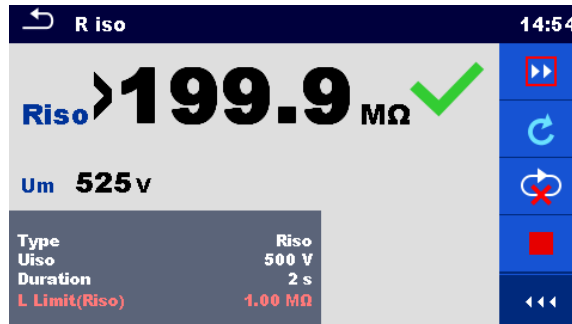









Figure 7.8: Auto Sequence® – Example of a finished measurement with options for proceeding

Options (during execution of an Auto Sequence®):

	Proceeds to the next step in the test sequence.
	Repeats the measurement. Displayed result of a single test will not be stored.
	Ends the Auto Sequence® and goes to Auto Sequence® result screen. Refer to chapter 7.2.3 <i>Auto Sequence® result</i> screen for more information.
	Exits the loop of single tests and proceeds to the next step in the Auto Sequence®.
	Opens menu for viewing parameters and limits of a current measurement.
 on 	
	Adds comment. The instrument opens keypad for entering a comment to a current measurement.

The offered options in the control panel depend on the selected single test, its result and the programmed test flow.

Notes:

- During Auto Sequences® the popup Warning messages (see chapter 4.5 *Symbols and messages*) are displayed only before the single test inside one Auto Sequence®. This default setting can be changed with appropriate flow command. For more information about programming Auto Sequences® refer to chapter *Appendix E Programming of Auto Sequences® on Metrel ES Manager*.
- If Inspection Expert mode flow command is set, the visual inspection screen and Functional inspection screen are displayed for 1 second and an overall PASS is automatically applied at the end of test. In between, the automatic procedure can be stopped and statuses can be applied manually.

7.2.3 Auto Sequence® result screen

After the Auto Sequence® is finished the Auto Sequence® result screen is displayed.

At the left side of the display the single tests and their statuses in the Auto Sequence® are shown.

In the middle of the display the header of the Auto Sequence® with Short code and description of the Auto Sequence® is displayed. At the top the overall Auto Sequence® result status is displayed. Refer to chapter 5.1.1 *Measurement statuses* for more information.

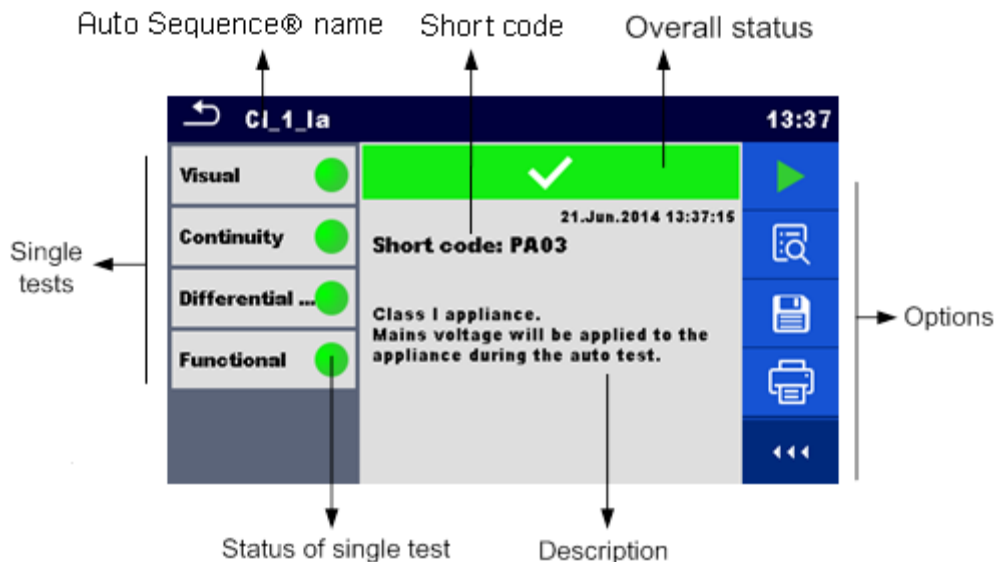

Figure 7.9: Auto Sequence® result screen

Options



Starts a new Auto Sequence®.



View results of individual measurements.

The instrument goes to menu for viewing details of the Auto Sequence®.



Saves the Auto Sequence® results.

A new Auto Sequence® was selected and started from a Structure object in the structure tree:

- The Auto Sequence® result will be saved under the selected Structure object.

A new Auto Sequence® was started from the Auto Sequence® main menu:

- Saving under the last selected Structure object will be offered by default. The user can select another Structure object or create a new Structure object. By pressing  in Memory organizer menu the Auto Sequence result is saved under selected location.

An empty measurement was selected in structure tree and started:

- The result(s) will be added to the Auto Sequence®. The Auto Sequence® will change its overall status from 'empty' to 'finished'.

An already carried out Auto Sequence® was selected in structure tree, viewed and then restarted:

- A new Auto Sequence result will be saved under the selected Structure object.



Print label.

For more information refer to chapter *Appendix C - Print labels and write / read RFID / NFC tags*



Print and Save Auto Sequence® results simultaneously.

Option is available if Devices parameter Auto save is set to On print, see chapter *4.10 Devices* for more information.



Write RFID / NFC tag. All data including Auto Sequence® results are written to the RFID/NFC writing device. Refer to *Appendix C - Print labels and write / read RFID / NFC tags* for supported tag types.



Write RFID / NFC tag and Save Auto Sequence® results simultaneously. Option is available if Devices parameter Auto save is set to On write, see chapter *4.10 Devices* for more information.



Adds comment.

The instrument opens keypad for entering a comment to Auto Sequence® result.

Note:

- Options menu content depends on Devices settings menu. If no writing device is set, then 'Print label' and 'Write RFID' icons are hidden. Only one writing device can be set at the same time.

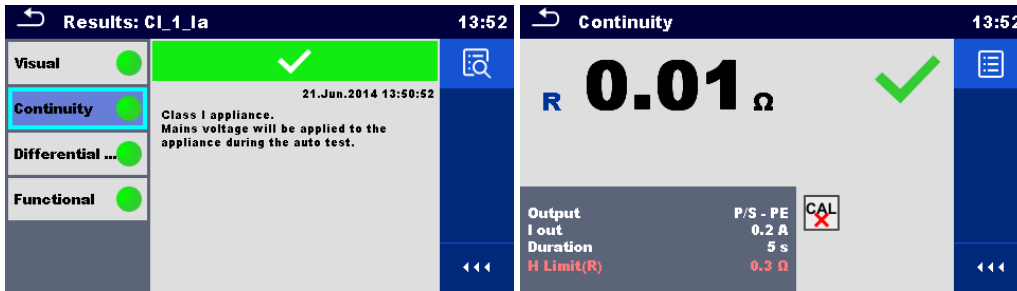

Figure 7.10: Details of menu for viewing details of Auto Sequence® results

Options (menu for viewing details of Auto Sequence® results):



Details of selected single test in Auto Sequence® are displayed.



View parameters and limits of selected single test.



Add comment to selected single test results.

View / edit comment to single test results, when recalled from memory.

7.2.4 Auto Sequence® memory screen

In Auto Sequence® memory screen details of the Auto Sequence® results can be viewed, labels can be printed and a new Auto Sequence® can be restarted.

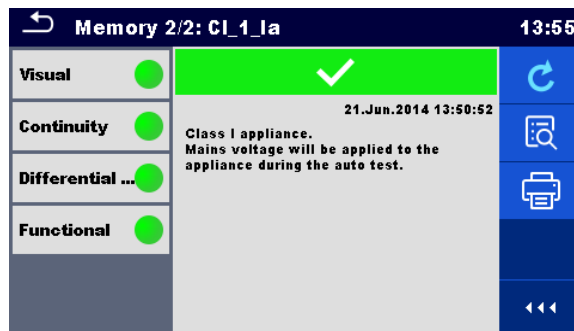

Figure 7.11: Auto Sequence® memory screen

Options:



Retest the Auto Sequence®.
Enters menu for a new Auto Sequence®.



Enters menu for viewing details of the Auto Sequence®. Refer to chapter 7.2.3 *Auto Sequence® result* screen for more information.



Print label.
For more information refer to chapter *Appendix C - Print labels and write / read RFID / NFC tags*



Write RFID / NFC tag. All data including Auto Sequence® results are written to the RFID / NFC writing device. Refer to *Appendix C - Print labels and write / read RFID / NFC tags* for supported tag types.

Note:

- Options menu content depends on Devices settings menu. If no writing device is set, then 'Print label' and 'Write RFID' icons are hidden. Only one writing device can be set at the same time.

8 Maintenance

8.1 Periodic calibration

It is essential that all measuring instruments are regularly calibrated in order for the technical specification listed in this manual to be guaranteed. We recommend an annual calibration.

8.2 Fuses

There are two fuses on the left side panel:

F1, F2: T 16 A / 250 V / (32 × 6,3) mm / 1500 A: intended for instrument protection.

For position of fuses refer to chapter 3.1 *Front panel*.

Warnings!

- Switch off the instrument and disconnect all test accessories and mains cord before replacing the fuses.
- Replace blown fuses with the same type as defined in this document.

8.3 Service

For repairs under or out of warranty please contact your distributor for further information.

Unauthorized person is not allowed to open the OmegaEE XD instrument. There are no user replaceable parts inside the instrument.

8.4 Cleaning

Use a soft, slightly moistened cloth with soap water or alcohol to clean the surface of OmegaEE XD instrument. Leave the instrument to dry totally before using it.

Notes:

- Do not use liquids based on petrol or hydrocarbons!
- Do not spill cleaning liquid over the instrument!

9 Communications

The instrument can communicate with the Metrel ES Manager PC software. The following action is supported:

- Saved results and Tree structure from Memory organizer can be downloaded and stored to a PC.
- Tree structure and Auto Sequences® from Metrel ES Manager PC software can be uploaded to the instrument.

Metrel ES Manager is a PC software running on Windows 10 and Windows 11.

There are three communication interfaces available on the instrument: RS-232, USB and Bluetooth. Instrument can also communicate to various external devices (android devices, test adapters, scanners, printers,...).

9.1 USB and RS232 communication with PC

The instrument automatically selects the communication mode according to detected interface. USB interface has priority.

How to establish an USB or RS-232 link:

-
- RS-232 communication: connect a PC COM port to the instrument PC / PRINTER connector using the RS232 serial communication cable;
-
- USB communication: connect a PC USB port to the instrument USB connector using the USB interface cable.
-
- Switch on the PC and the instrument.
-
- Run the *Metrel ES Manager* software.
 - Select communication port (COM port for USB communication is identified as **"Measurement Instrument USB VCom Port"**).
-
- The instrument is prepared to communicate with the PC.
-

9.2 Bluetooth communication

The internal Bluetooth module enables easy communication via Bluetooth with PC and Android devices.

How to configure a Bluetooth link between instrument and PC

-
- Switch On the instrument.
-
- On PC configure a Standard Serial Port to enable communication over Bluetooth link between instrument and PC. Usually, no code for pairing the devices is needed.
-
- Run the *Metrel ES Manager* software.
 - Select configured communication port.
-

-
- The instrument is prepared to communicate with the PC.
-

How to configure a Bluetooth link between instrument and Android device

-
- Switch On the instrument.
 - Some Android applications automatically carry out the setup of a Bluetooth connection. It is preferred to use this option if it exists. This option is supported by Metrel's Android applications.
 - If this option is not supported by the selected Android application, then configure a **Bluetooth link via Android device's Bluetooth configuration tool**. Usually, no code for pairing the devices is needed.
-
- The instrument and Android device are ready to communicate.
-

Notes:

- Sometimes there will be a demand from the PC or Android device to enter the code. **Enter code '1234' to correctly configure the Bluetooth link.**
- The name of correctly configured Bluetooth device must consist of the instrument type plus serial number, eg. *MI 3365-122404291*. If the Bluetooth module got another name, the configuration must be repeated.
- In case of serious troubles with the Bluetooth communication it is possible to reinitialize the internal Bluetooth module. The initialization is carried out during the Bluetooth init. **settings procedure. In case of a successful initialization "INITIALIZING... OK!" is displayed at the end of the procedure.** See chapter *Bluetooth initialization*.
- Check if there are available Metrel Android applications for this instrument.

9.3 **Bluetooth communication with printers and scanners**

OmegaEE XD instrument can communicate with supported Bluetooth printers and scanners. Contact Metrel or your distributor which external devices and functionalities are supported. See Chapter *4.10 Devices* for details how to set the external Bluetooth device.

9.4 **RS232 communication with other external devices**

It is possible to communicate with serial scanners and RFID / NFC reader / writer device via the BARCODE serial port and with serial printers via the PC / PRINTER serial port. Contact Metrel or your distributor which external devices and functionalities are supported. See Chapter *4.10 Devices* for details how to set the external device.

9.5 Connections to test adapters

9.5.1 Active 3 Phase Adapter /Plus (A 1322 / A 1422)

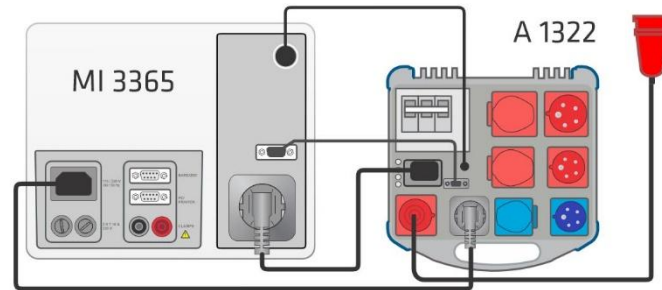

Figure 9.1: Connecting Active 3 Phase Adapter /plus (A 1322 / A 1422)

Notes:

- See 3-phase adapter Instruction manual for more details.
- Do not connect other devices than Metrel test adapters to the 3 PHASE ADAPTER connector.

9.5.2 3-phase Active Leakage Adapter (A 1830)

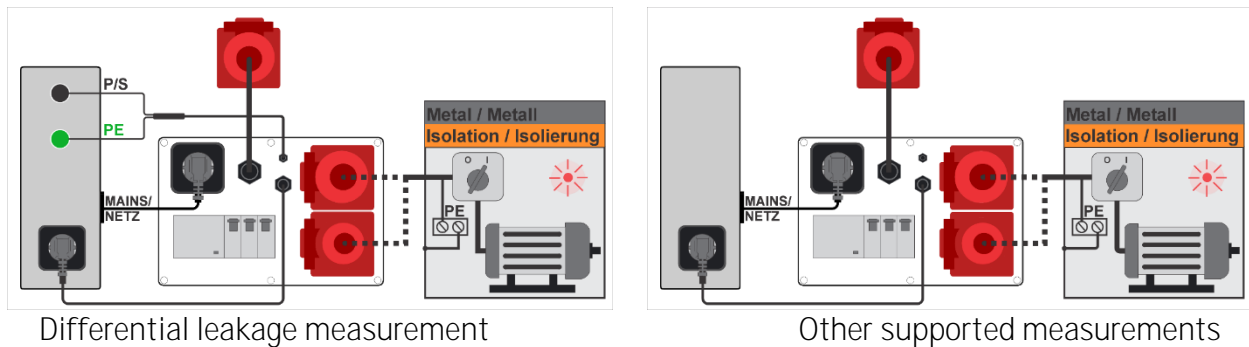

Figure 9.2: Connecting 3-phase Active Leakage Adapter (A 1830)

Notes:

- Set measurement parameter Adapter to A 1830, to configure operation with 3-phase Active Leakage Adapter.
- See 3-phase Active Leakage Adapter (A 1830) Instruction manual for more details.

9.5.3 110 V Test Adapter (A 1474)

110 V Adapter (A 1474) is used as interface to connect 110 V appliances to the instrument.



Figure 9.3: Connecting 110 V Test Adapter (A 1474)

Note:

- ▶ Instrument detects the adapter and blocks measurements if mains voltage is too high.

9.5.4 Tip Commander (A 1694)

Tip Commander (A 1694) enables remote controlled execution of measurements.



Figure 9.4: Connecting Tip Commander (A 1694)

Note:

- ▶ Tip Commander (A 1694) should be enabled in Settings menu for operation.

10 Technical specifications

10.1 Continuity // Protective earth resistance

Continuity (0.2 A)

	Range	Resolution	Accuracy
R	0.00 Ω ... 19.99 Ω	0.01 Ω	$\pm(2\%$ of reading + 2 D)
	20.0 Ω ... 99.9 Ω	0.1 Ω	$\pm 3\%$ of reading
	100.0 Ω ... 199.9 Ω	0.1 Ω	$\pm 5\%$ of reading
	200 Ω ... 1999 Ω	1 Ω	$\pm 5\%$ of reading

Operating range (acc. to EN 61557-4).....0.08 Ω ... 1999 Ω

Continuity (10 A, 25 A)

	Range	Resolution	Accuracy
R	0.00 Ω ... 19.99 Ω	0.01 Ω	$\pm(2\%$ of reading + 2 D)
	20.0 Ω ... 99.9 Ω	0.1 Ω	$\pm 3\%$ of reading
	100.0 Ω ... 199.9 Ω	0.1 Ω	$\pm 5\%$ of reading
	200 Ω ... 999 Ω	1 Ω	indicative

Operating range (acc. to EN 61557-4).....0.08 Ω ... 199.9 Ω

Test currents0.2 A, 10 A, 25 A

Current source (at nominal mains voltage, use of standard accessories)

..... > 0.2 A at $R < 2\ \Omega$

..... > 10 A at $R < 0.1\ \Omega$ at 230 V

..... > 25 A into short circuit at 230 V

Open circuit voltage..... < 9 V a.c.

Test terminals:

Continuity

R (200 mA)	P/S – PE, Socket PE; Socket PE – IEC PE
R (10 A, 25 A)	P/S – Socket PE; Socket PE – IEC PE

Protective earth resistance

R (200 mA)	P/AP – PE, Socket PE
R (10 A, 25 A)	P/AP – Socket PE

10.2 Insulation Resistance (Riso, Riso-S)

Insulation resistance, Insulation resistance –S (250 V, 500 V)

	Range	Resolution	Accuracy
Riso Riso-S	0.00 M Ω ... 19.99 M Ω	0.01 M Ω	$\pm(3\%$ of reading + 2 D)
	20.0 M Ω ... 99.9 M Ω	0.1 M Ω	$\pm 5\%$ of reading
	100.0 M Ω ... 199.9 M Ω	0.1 M Ω	$\pm 10\%$ of reading

Operating range (acc. to EN 61557-2) 0.08 M Ω ... 199.9 M Ω

Output voltage

	Range	Resolution	Accuracy
Um	0 V ... 600 V	1 V	±(3 % of reading + 2 D)

Nominal voltages Un 250 V, 500 V (- 0 %, + 10 %)

Short circuit current max. 2.0 mA

Test terminals:

Riso	LN, Socket LN – PE, Socket PE, P/S
Riso-S	LN, Socket LN – P/S

10.3 Sub-Leakage (Isub, Isub-S)

Substitute leakage current, Substitute leakage current - S

	Range	Resolution	Accuracy
Isub	0.00 mA ... 1.99 mA	0.01 mA	±(3 % of reading + 3 D)
Isub-S	2.00 mA ... 19.99 mA	0.01 mA	± 5 % of reading

Operating range (acc. to EN 61557-16).....0.02 mA ... 19.99 mA

Open circuit voltage230 V a.c., 110 V a.c.

Short circuit current ≤ 2 mA

Current calculated to mains supply voltage (110 V or 230 V) is displayed.

Test terminals:

Isub	LN, Socket LN – PE, Socket PE, P/S
Isub-S	LN, Socket LN – P/S

10.4 Differential Leakage

Differential leakage current

	Range	Resolution	Accuracy
Idiff	0.000 mA ... 1.999 mA	1 µA	±(3 % of reading + 3 D)
	2.00 mA ... 19.99 mA	0.01 mA	± 5 % of reading

Operating range (acc. to EN 61557-16).....0.010 mA ... **19.99 mA**

Power (active)

	Range	Resolution	Accuracy
P	0.00 W ... 19.99 W	0.01 W	±(5 % of reading + 5 D)
	20.0 W ... 199.9 W	0.1 W	± 5 % of reading
	200 W ... 1999 W	1 W	± 5 % of reading
	2.00 kW ... 3.70 kW	10 W	± 5 % of reading

Influence of load current < 0.02 mA/A

Differential leakage current (with A 1830)

	Range	Resolution	Accuracy
Idiff	0.10 mA ... 1.99 mA	0.01 mA	±(5 % of reading + 20 D)
	2.00 mA ... 19.99 mA	0.01 mA	± 5 % of reading

Operating range (acc. to EN 61557-16)..... 0.10 mA ... 19.99 mA

Influence of load current ≤ 0.03 mA/A

Test terminals:

Idiff	Socket L,N - Socket PE, P/S
Idiff (with A 1830)	P/S - PE
P	Socket L - Socket N

10.5 Touch Leakage

Touch leakage current

	Range	Resolution	Accuracy
Itou Itou, a.c. Itou, d.c.	0.000 mA ... 1.999 mA	1 µA	±(3 % of reading + 3 D)
	2.00 mA ... 19.99 mA	0.01 mA	± 5 % of reading

Operating range (acc. to EN 61557-16)..... 0.010 mA ... 19.99 mA

Power (active)

	Range	Resolution	Accuracy
P	0.00 W ... 19.99 W	0.01 W	±(5 % of reading + 5 D)
	20.0 W ... 199.9 W	0.1 W	± 5 % of reading
	200 W ... 1999 W	1 W	± 5 % of reading
	2.00 kW ... 3.70 kW	10 W	± 5 % of reading

Test terminals:

Itou	Socket L,N - P/S
P	Socket L - Socket N

10.6 Ipe Leakage

PE leakage current

	Range	Resolution	Accuracy
Ipe Ipe, a.c. Ipe, d.c.	0.000 mA ... 1.999 mA	1 µA	±(3 % of reading + 3 D)
	2.00 mA ... 19.99 mA	0.01 mA	± 5 % of reading

Operating range (acc. to EN 61557-16)..... 0.010 mA ... 19.99 mA

Power (active)

	Range	Resolution	Accuracy
P	0.00 W ... 19.99 W	0.01 W	±(5 % of reading + 5 D)
	20.0 W ... 199.9 W	0.1 W	± 5 % of reading
	200 W ... 1999 W	1 W	± 5 % of reading
	2.00 kW ... 3.70 kW	10 W	± 5 % of reading

Test terminals:

I _{pe}	Socket L,N – Socket PE
P	Socket L – Socket N

10.7 I_{pe}+I_{floating} input (I_{pe}+I_{fi})

PE leakage current

	Range	Resolution	Accuracy
I _{pe}	0.000 mA ... 1.999 mA	1 µA	±(3 % of reading + 3 D)
	2.00 mA ... 19.99 mA	0.01 mA	± 5 % of reading

Operating range (acc. to EN 61557-16).....0.010 mA ... 19.99 mA

Differential leakage current

	Range	Resolution	Accuracy
I _{diff}	0.000 mA ... 1.999 mA	1 µA	±(3 % of reading + 3 D)
	2.00 mA ... 19.99 mA	0.01 mA	± 5 % of reading

Operating range (acc. to EN 61557-16).....0.010 mA ... 19.99 mA

Influence of load current < 0.02 mA/A

I_{fi}

	Range	Resolution	Accuracy
I _{fi}	0.000 mA ... 1.999 mA	1 µA	±(3 % of reading + 3 D)
	2.00 mA ... 19.99 mA	0.01 mA	± 5 % of reading

Operating range (acc. to EN 61557-16).....0.020 mA ... 19.99 mA

Output voltage ≤ 250 V a.c max, ≤ 2 mA.

I_{pe}+I_{fi} / I_{diff}+I_{fi}

	Range	Resolution	Accuracy
I _{pe} +I _{fi}	0.000 mA ... 1.999 mA	1 µA	Calculated values
I _{diff} +I _{fi}	2.00 mA ... 19.99 mA	0.01 mA	

Test terminals:

I _{pe}	Socket L,N – Socket PE
I _{fi}	P/S – Socket PE

10.8 Itouch+Ifloating input (Itou+Ifi)

Touch leakage current

	Range	Resolution	Accuracy
Itou	0.000 mA ... 1.999 mA	1 μ A	$\pm(3\%$ of reading + 3 D)
	2.00 mA ... 19.99 mA	0.01 mA	$\pm 5\%$ of reading

Operating range (acc. to EN 61557-16).....0.010 mA ... 19.99 mA

Ifi

	Range	Resolution	Accuracy
Ifi	0.000 mA ... 1.999 mA	1 μ A	$\pm(3\%$ of reading + 3 D)
	2.00 mA ... 19.99 mA	0.01 mA	$\pm 5\%$ of reading

Operating range (acc. to EN 61557-16).....0.020 mA ... 19.99 mA

Output voltage ≤ 250 V a.c max, ≤ 2 mA.

Itouch+Ifi

	Range	Resolution	Accuracy
Itou+Ifi	0.000 mA ... 1.999 mA	1 μ A	Calculated values
	2.00 mA ... 19.99 mA	0.01 mA	

Test terminals:

Itouch	Socket L,N - P/S
Ifi	LN - P/S

10.9 Power

Power (active)

	Range	Resolution	Accuracy
P	0.00 W ... 19.99 W	0.01 W	$\pm(5\%$ of reading + 5 D)
	20.0 W ... 199.9 W	0.1 W	$\pm 5\%$ of reading
	200 W ... 1999 W	1 W	$\pm 5\%$ of reading
	2.00 kW ... 3.70 kW	10 W	$\pm 5\%$ of reading

Power (apparent)

	Range	Resolution	Accuracy
S	0.00 VA ... 19.99 VA	0.01 VA	$\pm(5\%$ of reading + 10 D)
	20.0 VA ... 199.9 VA	0.1 VA	$\pm 5\%$ of reading
	200 VA ... 1999 VA	1 VA	$\pm 5\%$ of reading
	2.00 kVA ... 3.70 kVA	10 VA	$\pm 5\%$ of reading

Power (reactive)

	Range	Resolution	Accuracy
Q	0.00 var ... 19.99 var	0.01 var	$\pm(5\%$ of reading + 10 D)
	20.0 var ... 199.9 var	0.1 var	$\pm 5\%$ of reading
	200 var ... 1999 var	1 var	$\pm 5\%$ of reading
	2.00 kvar ... 3.70 kvar	10 var	$\pm 5\%$ of reading

Power factor

	Range	Resolution	Accuracy
PF	0.00i ... 1.00i 0.00c ... 1.00c	0.01	$\pm(5\%$ of reading + 5 D)

Total Harmonic Distortion (voltage)

	Range	Resolution	Accuracy
THDU	0.0 % ... 99.9 %	0.1 %	$\pm(5 \% \text{ of reading} + 5 \text{ D})$

Total Harmonic Distortion (current)

	Range	Resolution	Accuracy
THDI	0 mA ... 999 mA	1 mA	$\pm(5 \% \text{ of reading} + 5 \text{ D})$
	1.00 A ... 16.00 A	0.01 A	$\pm 5 \% \text{ of reading}$

Cosine Φ

	Range	Resolution	Accuracy
Cos Φ	0.00i ... 1.00i 0.00c ... 1.00c	0.01	$\pm(5 \% \text{ of reading} + 5 \text{ D})$

Current

	Range	Resolution	Accuracy
I	0 mA ... 999 mA	1 mA	$\pm(3 \% \text{ of reading} + 5 \text{ D})$
	1.00 A ... 16.00 A	0.01 A	$\pm 3 \% \text{ of reading}$

Voltage

	Range	Resolution	Accuracy
U	0.0 V ... 199.9 V	0.1 V	$\pm(3 \% \text{ of reading} + 10 \text{ D})$
	200 V ... 264 V	1 V	$\pm 3 \% \text{ of reading}$

Accuracy is valid within $0.5c \leq PF \leq 0.8i$

Test terminals:

P,S,Q,PF,THDU,THDI, Cos Φ , I, U	Socket L - Socket N
---------------------------------------	---------------------

10.10 Leak's & Power

Touch leakage current

	Range	Resolution	Accuracy
Itou	0.000 mA ... 1.999 mA	1 μ A	$\pm(3 \% \text{ of reading} + 3 \text{ D})$
Itou, a.c. Itou, d.c.	2.00 mA ... 19.99 mA	0.01 mA	$\pm 5 \% \text{ of reading}$

Operating range (acc. to EN 61557-16).....0.010 mA ... 19.99 mA

Differential leakage current

	Range	Resolution	Accuracy
Idiff	0.000 mA ... 1.999 mA	1 μ A	$\pm(3 \% \text{ of reading} + 3 \text{ D})$
	2.00 mA ... 19.99 mA	0.01 mA	$\pm 5 \% \text{ of reading}$

Operating range (acc. to EN 61557-16).....0.010 mA ... 19.99 mA

Influence of load current < 0.02 mA/A

Power (active)

	Range	Resolution	Accuracy
P	0.00 W ... 19.99 W	0.01 W	±(5 % of reading + 5 D)
	20.0 W ... 199.9 W	0.1 W	± 5 % of reading
	200 W ... 1999 W	1 W	± 5 % of reading
	2.00 kW ... 3.70 kW	10 W	± 5 % of reading

Power (apparent)

	Range	Resolution	Accuracy
S	0.00 VA ... 19.99 VA	0.01 VA	±(5 % of reading + 10 D)
	20.0 VA ... 199.9 VA	0.1 VA	± 5 % of reading
	200 VA ... 1999 VA	1 VA	± 5 % of reading
	2.00 kVA ... 3.70 kVA	10 VA	± 5 % of reading

Power (reactive)

	Range	Resolution	Accuracy
Q	0.00 var ... 19.99 var	0.01 var	±(5 % of reading + 10 D)
	20.0 var ... 199.9 var	0.1 var	± 5 % of reading
	200 var ... 1999 var	1 var	± 5 % of reading
	2.00 kvar ... 3.70 kvar	10 var	± 5 % of reading

Power factor

	Range	Resolution	Accuracy
PF	0.00i ... 1.00i 0.00c ... 1.00c	0.01	±(5 % of reading + 5 D)

Total Harmonic Distortion (voltage)

	Range	Resolution	Accuracy
THDU	0.0 % ... 99.9 %	0.1 %	±(5 % of reading + 5 D)

Total Harmonic Distortion (current)

	Range	Resolution	Accuracy
THDI	0 mA ... 999 mA	1 mA	±(5 % of reading + 5 D)
	1.00 A ... 16.00 A	0.01 A	± 5 % of reading

Cosine Φ

	Range	Resolution	Accuracy
Cos Φ	0.00i ... 1.00i 0.00c ... 1.00c	0.01	±(5 % of reading + 5 D)

Current

	Range	Resolution	Accuracy
I	0 mA ... 999 mA	1 mA	$\pm(3\% \text{ of reading} + 5 \text{ D})$
	1.00 A ... 16.00 A	0.01 A	$\pm 3\% \text{ of reading}$

Voltage

	Range	Resolution	Accuracy
U	0.0 V ... 199.9 V	0.1 V	$\pm(3\% \text{ of reading} + 10 \text{ D})$
	200 V ... 264 V	1 V	$\pm 3\% \text{ of reading}$

Accuracy is valid within $0.5c \leq PF \leq 0.8i$

Test terminals:

Itou	Socket L,N - P/S
Idiff	Socket L,N - Socket PE, P/S
P,S,Q,PF,THDU,THDI, Cos Φ , I, U	Socket L - Socket N

10.11 PRCD test

Trip-out time

	Range	Resolution	Accuracy
$t_{\Delta N}$	0.0 ms ... 300.0 ms (999.9 ms*) ($\frac{1}{2} \times I_{\Delta N}$)	0.1 ms	$\pm 3 \text{ ms}$
	0.0 ms ... 300.0 ms ($I_{\Delta N}$)	0.1 ms	$\pm 3 \text{ ms}$
	0.0 ms ... 40.0 ms ($5 \times I_{\Delta N}$)	0.1 ms	$\pm 3 \text{ ms}$

*According to standard AS/NZS 3017

Trip-out current

	Range	Resolution	Accuracy
I_{Δ}	$0.2 \times I_{\Delta N} \dots 2.2 \times I_{\Delta N}$	$0.05 \times I_{\Delta N}$	$\pm 0.1 \times I_{\Delta N}$

Test current type: sine-wave (AC), pulsed (A, F), smooth DC (B, B+)

Test currents ($I_{\Delta N}$): 10 mA, 15 mA, 30 mA

.....100 mA and 300 mA with A1322, A1422

Test current size (PRCD standard is AS/NZS 3017)..... $\pm 5\%$

Test current size (general).....-0/+10%

Test terminals:

$t_{\Delta N}$, I_{Δ}	Socket - IEC
-------------------------------	--------------

10.12 RCD test

Trip-out time

	Range	Resolution	Accuracy
t Δ N	0.0 ms ... 300.0 ms (999.9 ms*) ($\frac{1}{2} \times I_{\Delta N}$)	0.1 ms	± 3 ms
	0.0 ms ... 300.0 ms ($I_{\Delta N}$)	0.1 ms	± 3 ms
	0.0 ms ... 40.0 ms ($5 \times I_{\Delta N}$)	0.1 ms	± 3 ms

*According to standard AS/NZS 3017

Trip-out current

	Range	Resolution	Accuracy
I Δ	$0.2 \times I_{\Delta N} \dots 2.2 \times I_{\Delta N}$	$0.05 \times I_{\Delta N}$	$\pm 0.1 \times I_{\Delta N}$

Contact voltage

	Range	Resolution	Accuracy
U _c	0.0 V ... 19.9 V	0.1 V	(-0 % / +15 %) of reading ± 20 D
	20.0 V ... 99.9 V	0.1 V	(-0 % / +15 %) of reading

Test current type: sine-wave (AC), pulsed (A,F), smooth DC (B,B+)

Test currents (I Δ N): 10 mA, 15 mA, 30 mA

Test current size (RCD standard is AS/NZS AS/NZS)..... $\pm 5\%$

Test current size (EN 61008/EN 61009)..... -0/+10%

Test terminals:

t Δ N, I Δ	Mains Socket
--------------------------	--------------

10.13 PE conductor (PRCD)

PE conductor (Type = 2 pole, 3 pole, S(3 pole), S+)

	Range	Resolution	Accuracy
R	0.00 Ω ... 19.99 Ω	0.01 Ω	$\pm(2\%$ of reading + 2 D)

Operating range (acc. to EN 61557-4).....0.08 Ω ... 19.99 Ω

Current source (at nominal mains voltage, use of standard accessories)

..... > 0.2 A at R < 2 Ω

Open circuit voltage..... < 9 V a.c.

Upper range is limited by polarity pretest.

Test terminals:

R	Socket PE – IEC PE
---	--------------------

PE conductor (Type = K/ Di (varistor))

Test principle:

A voltage is applied between PE connections of the PRCD-K. **There is a 'PASS' if PRCD trips.**

Open circuit voltage 24 V \pm 5 %

Output resistance 220 Ω \pm 10 % ($I_{\Delta N}$ = 30 mA), 620 Ω \pm 10 % ($I_{\Delta N}$ = 10 mA)

Test terminals:

Result	Socket – IEC
--------	--------------

10.14 Open conductor (PRCD)

Test principle:

Mains voltage is applied to the mains test socket. Disconnection of the L, N and PE connections is performed inside the instrument. **There is a 'PASS' if the PRCD trips.**

Test terminals:

L open, N open, PE open	Socket – IEC
-------------------------	--------------

10.15 PRCD PE probe test

Test principle:

Mains voltage is applied to the mains test socket. A safe voltage sufficiently high to activate the protection circuit in the PRCD is applied to the P/S terminal.

Test voltage (active) > 100 V a.c.

Maximal current < 1 mA

Test terminals:

Result (manual)	Socket, P/S
Result (auto)	Socket – IEC, P/S

10.16 EV RCD test

Trip-out time

Result	Test current	Range	Resolution	Accuracy	
$t_{\Delta N}$	a.c. pulse d.c. (A)	$\frac{1}{2} \times I_{\Delta N}$	0.0 ms ... 300.0 ms	0.1 ms	± 3 ms
		$I_{\Delta N}$	0.0 ms ... 300.0 ms	0.1 ms	± 3 ms
		$2 \times I_{\Delta N}$	0.0 ms ... 150.0 ms	0.1 ms	± 3 ms
		$5 \times I_{\Delta N}$	0.0 ms ... 40.0 ms	0.1 ms	± 3 ms
	smooth d.c.	$\frac{1}{2} \times I_{\Delta N}$	0.0 ms ... 999.9 ms 1.00 s ... 9.99 s	0.1 ms 0.01 s	± 3 ms ± 30 ms
		$I_{\Delta N}$	0.0 ms ... 999.9 ms 1.00 s ... 9.99 s	0.1 ms 0.01 s	± 3 ms ± 30 ms
$10 \times I_{\Delta N}$		0.0 ms ... 300.0 ms	0.1 ms	± 3 ms	

Trip-out current

Result	Test current	Range	Resolution	Accuracy
I_{Δ}	a.c.	$0.2 \times I_{\Delta N} \dots 1.1 \times I_{\Delta N}$	$0.05 \times I_{\Delta N}$	$\pm 0.1 \times I_{\Delta N}$
	pulse d.c. (A)	$0.2 \times I_{\Delta N} \dots 1.5 \times I_{\Delta N}$	$0.05 \times I_{\Delta N}$	$\pm 0.1 \times I_{\Delta N}$
	smooth d.c.	1.5 mA ... 6.0 mA	$0.05 \times I_{\Delta N}$	$\pm 0.1 \times I_{\Delta N}$

Test current type: sine-wave (a.c.), pulsed d.c. (A), smooth d.c.

Test currents ($I_{\Delta N}$): 6 mA (smooth d.c.), 10 mA, 15 mA, 30 mA

Test current size: -0/+10%

Test terminals:

$t_{\Delta N}, I_{\Delta}$	Mains Socket
----------------------------	--------------

10.17 EVSE Diagnostic test (A 1632)

This test is performed in combination with an external test adapter / instrument. For technical specification refer to *A 1632 eMobility Analyser Instruction manual*.

10.18 PE conductor (EV RCD)

PE conductor (I test = Standard)

	Range	Resolution	Accuracy
R	0.00 Ω ... 19.99 Ω	0.01 Ω	$\pm(2\%$ of reading + 2 D)

Operating range (acc. to EN 61557-4) 0.08 Ω ... 19.99 Ω

Current source (at nominal mains voltage, use of standard accessories)

..... > 0.2 A at R < 2 Ω

Open circuit voltage < 9 V a.c.

Upper range is limited by polarity pretest.

PE conductor (I test = Low)

	Range	Resolution	Accuracy
R	0.00 Ω ... 19.99 Ω	0.01 Ω	$\pm(5\%$ of reading + 10 D)
	20.0 Ω ... 199.9 Ω	0.1 Ω	indicative
	200 Ω ... 999 Ω	1 Ω	

Current sourceca 5 mA at $R < 2\ \Omega$

Test terminals:

R	Socket PE – IEC PE
---	--------------------

10.19 Polarity

Test voltage (normal) < 50 V

Test voltage (active) mains voltage

Power consumption of tested device during the active test < 25 VA

Test terminals:

Result (normal, active)	Socket – IEC
-------------------------	--------------

10.20 Clamp current

True RMS current using current clamp A 1579

	Range	Resolution	Accuracy
I Idiff Ipe	0.10 mA ... 9.99 mA	0.01 mA	$\pm(5\%$ of reading + 10 D)
	10.0 mA ... 99.9 mA	0.1 mA	$\pm(5\%$ of reading + 5 D)
	100 mA ... 999 mA	1 mA	$\pm(5\%$ of reading + 5 D)
	1.00 A ... 9.99 A	0.01 A	$\pm(5\%$ of reading + 5 D)
	10.0 A ... 24.9 A	0.1 A	$\pm(5\%$ of reading + 5 D)

Nominal frequency range 50 Hz ... 200 Hz

Test terminals:

I, Idiff, Ipe	CLAMPS terminals
---------------	------------------

10.21 Flash test

Current a.c. (apparent)

	Range	Resolution	Accuracy
I	0.00 mA ... 2.50 mA	0.01 mA	±(5 % of reading + 5 D)

Open circuit test voltage..... 1500 V, 3000 V (-0/+5%) at supply voltage 115 V, 230 V

Short circuit current..... < 3.5 mA

Output resistance: 480 kΩ@1500 V, 960 kΩ@3000 V

Test terminals:

I (1500 V)	Socket LN – Socket PE
I (3000 V)	3 kV Socket LN – FLASH (1.5 kV Socket LN – Socket PE, 1.5 kV FLASH – Socket PE)

10.22 Insulation resistance Riso (welding equipment)

Riso

	Range	Resolution	Accuracy
Riso	0.00 MΩ ... 19.99 MΩ	0.01 MΩ	±(3 % of reading + 2 D)
	20.0 MΩ ... 99.9 MΩ	0.1 MΩ	± 5 % of reading
	100.0 MΩ ... 199.9 MΩ	0.1 MΩ	± 10 % of reading

Operating range (acc. to EN 61557-2) 0.08 MΩ ... 199.9 MΩ

Output voltage

	Range	Resolution	Accuracy
Um	0 V ... 600 V	1 V	±(3 % of reading + 2 D)

Nominal voltages Un 500 V (- 0 %, + 10 %)

Short circuit current..... max. 2.0 mA

Test terminals:

Riso LN-W	A 1422: Socket L1 L2 L3 N (16A-5p, 32A-5p or 16A-3p) – W1 W2
Riso W-PE	A 1422: Socket PE (16A-5p, 32A-5p or 16A-3p) – W1 W2
Riso LN-PE	A 1422: Socket L1 L2 L3 N (16A-5p, 32A-5p or 16A-3p) – Socket PE (16A-5p, 32A-5p or 16A-3p)
Riso LN (Class II) - P/S	A 1422: Socket L1 L2 L3 N (16A-5p, 32A-5p or 16A-3p) – MI 3365: P/S

10.23 Welding Circuit leakage (I_{leak W-PE})

Refer to chapter *Technical specifications* in 3-phase adapter instrument user manual.

10.24 Protective Conductor current (I_{diff})

Refer to chapter *Technical specifications* in 3-phase adapter instrument user manual.

10.25 No-load voltage

Refer to chapter *Technical specifications* in 3-phase adapter instrument user manual.

10.26 Insulation Resistance R_{iso} (medical equipment)

R_{iso}

	Range	Resolution	Accuracy
R _{iso}	0.00 MΩ ... 19.99 MΩ	0.01 MΩ	±(3 % of reading + 2 D)
	20.0 MΩ ... 199.9 MΩ	0.1 MΩ	± 5 % of reading

Operating range (acc. to EN 61557-2) 0.08 MΩ ... **199.9 MΩ**

Output voltage

	Range	Resolution	Accuracy
U _m	0 V ... 600 V	1 V	±(3 % of reading + 2 D)

Nominal voltages U_n 500 V (- 0 %, + 10 %)

Short circuit current max. 2.0 mA

Test terminals:

R _{iso} (LN-PE)	LN, Socket LN - PE, Socket PE
R _{iso} (LN-P/S)	LN, Socket LN - P/S
R _{iso} (LN-AP)	LN, Socket LN - P/AP
R _{iso} (PE-AP)	PE, Socket PE - P/AP

10.27 Equipment Leakage

Equipment leakage current (direct, differential, alternative)

	Range	Resolution	Accuracy
I _{eq}	0.000 mA ... 1.999 mA	1 μA	±(3 % of reading + 3 D)
	2.00 mA ... 19.99 mA	0.01 mA	± 5 % of reading

Operating range direct and differential method (acc. to EN 61557-16) **0.010 mA ... 19.99 mA**

Operating range alternative method (acc. to EN 61557-16).....0.020 mA ... 19.99 mA

U_{lpe} (direct, differential, alternative)

	Range	Resolution	Accuracy
U _{lpe}	0 V ... 299 V	1 V	±(2 % of reading + 2 D)

Power (direct, differential)

	Range	Resolution	Accuracy
P	0.00 W ... 19.99 W	0.01 W	±(5 % of reading + 5 D)
	20.0 W ... 199.9 W	0.1 W	± 5 % of reading
	200 W ... 1999 W	1 W	± 5 % of reading
	2.00 kW ... 3.70 kW	10 W	± 5 % of reading

Influence of load current (differential method) < 0.02 mA/A

Test terminals:

I _{eq} (alternative)	LN, Socket LN - PE, Socket PE, P/S, P/AP
I _{eq} (direct, differential)	Socket L,N - PE, Socket PE, P/S, P/AP
U _{lpe}	Socket L - Socket PE
P (direct, differential)	Socket L - Socket N

10.28 Applied Part Leakage

Applied Part leakage current (direct, alternative)

	Range	Resolution	Accuracy
I _{ap}	0.000 mA ... 1.999 mA	1 µA	±(3 % of reading + 3 D)
	2.00 mA ... 19.99 mA	0.01 mA	± 5 % of reading

Operating range direct method (acc. to EN 61557-16).....0.010 mA ... 19.99 mA

Operating range alternative method (acc. to EN 61557-16).....0.020 mA ... 19.99 mA

U_{ap} (direct, alternative)

	Range	Resolution	Accuracy
U _{ap}	0 V ... 299 V	1 V	±(2 % of reading + 2 D)

Power (direct)

	Range	Resolution	Accuracy
P	0.00 W ... 19.99 W	0.01 W	±(5 % of reading + 5 D)
	20.0 W ... 199.9 W	0.1 W	± 5 % of reading
	200 W ... 1999 W	1 W	± 5 % of reading
	2.00 kW ... 3.70 kW	10 W	± 5 % of reading

Voltage source: ≤ 250 V a.c max, ≤ 2 mA.

Test terminals:

Iap (alternative)	Socket LNPE, PE – P/AP
Iap (direct)	Socket L,N,PE, PE – P/AP
Uap	Socket PE, PE – P/AP
P	Socket L – Socket N

10.29 Touch Current (medical equipment)

Touch current

	Range	Resolution	Accuracy
Itou	0.000 mA ... 1.999 mA	1 μ A	$\pm(3\%$ of reading + 3 D)
	2.00 mA ... 19.99 mA	0.01 mA	$\pm 5\%$ of reading

Operating range (acc. to EN 61557-16).....0.010 mA ... 19.99 mA

Power

	Range	Resolution	Accuracy
P	0.00 W ... 19.99 W	0.01 W	$\pm(5\%$ of reading + 5 D)
	20.0 W ... 199.9 W	0.1 W	$\pm 5\%$ of reading
	200 W ... 1999 W	1 W	$\pm 5\%$ of reading
	2.00 kW ... 3.70 kW	10 W	$\pm 5\%$ of reading

Ulpe

	Range	Resolution	Accuracy
Ulpe	0 V ... 299 V	1 V	$\pm(2\%$ of reading + 2 D)

Test terminals

Itou	Socket L,N – P/S
Ulpe	Socket L – Socket PE
P	Socket L – Socket N

10.30 Patient Leakage

Patient leakage

	Range	Resolution	Accuracy
I _p	0.000 mA ... 1.999 mA	1 μ A	$\pm(3\%$ of reading + 3 D)
I _p , a.c. I _p , d.c.	2.00 mA ... 19.99 mA	0.01 mA	$\pm 5\%$ of reading

Power

	Range	Resolution	Accuracy
P	0.00 W ... 19.99 W	0.01 W	$\pm(5\%$ of reading + 5 D)
	20.0 W ... 199.9 W	0.1 W	$\pm 5\%$ of reading
	200 W ... 1999 W	1 W	$\pm 5\%$ of reading
	2.00 kW ... 3.70 kW	10 W	$\pm 5\%$ of reading

U_{lpe}

	Range	Resolution	Accuracy
U _{lpe}	0 V ... 299 V	1 V	±(2 % of reading + 2 D)

Test terminals

I _p	Socket L,N - P/S
U _{lpe}	Socket L - Socket PE
P	Socket L - Socket N

10.31 SELV/PELV Voltage

Voltage (U_{trms}, U_{ac})

	Range	Resolution	Accuracy
U _{trms}	0.0 V ... 199.9 V	0.1 V	±(2 % of reading + 10 D)
U _{ac}	200 V ... 264 V	1 V	± 2 % of reading

Voltage (U_{dc})

	Range	Resolution	Accuracy
U _{dc}	±(0.0 V ... 199.9 V)	0.1 V	±(2 % of reading + 10 D)
	±(200 V ... 264 V)	1 V	± 2 % of reading

Frequency

	Range	Resolution	Accuracy
Freq	0 Hz (DC)		Indicative
	15.0 Hz ... 499.9 Hz	0.1 Hz	±(0.2 % of reading + 1 D)

Test terminals

U _{trms} , U _{ac} , U _{dc}	P/S, V - PE, COM
---	------------------

Result type True r.m.s. (TRMS), AC, DC

Input resistance input P/S 200 k Ω to earth,
input PE 200 k Ω to earth

Nominal frequency range 0 Hz (DC), 15 Hz ... 500 Hz

Bandwidth 1 kHz

10.32 Fuse checker

Test voltage.....	5 Vdc
Test current	< 1 mA
Result.....	Continuous sound – Fuse OK No sound – Fuse blown

Test terminals

Fuse	Fuse checker pins
------	-------------------

10.33 General data

Mains supply

Supply voltage, frequency	110 V / 230 V AC, 50 Hz / 60 Hz
Supply voltage tolerance	±10 %
Max. power consumption	300 VA (without load on test socket)
Max. load	10 A continuous, 16 A short duration, 1.5 kW motor
Mains supply overvoltage category.....	CAT II / 300V
Altitude	≤ 2000 m

Measuring categories

Instrument:	Cat II / 300 V
Test socket:	Cat II / 300 V
Plug test cable:	Cat II / 300 V
Altitude	≤ 2000 m

Protection classifications

Power supply	Class I, mains supply, Class II, only battery supply
Pollution degree	2
Degree of protection.....	IP 40 IP 20 (mains test socket)
Case.....	Shock proof plastic / portable
Operation	Indoor use

Display.....	Colour TFT display, 4.3 inch, 480 x 272 pixels
Touch screen	Capacitive

EMC classifications

Emission.....	Class B
Immunity.....	Industrial environment

Communication

Memory	depends on microSD card size
RS232 interfaces	2
USB 2.0.....	Standard USB Type B
Bluetooth	Class 1

Dimensions (w×h×d):.....31 cm × 13 cm × 25 cm
Weight6.1 kg

Reference conditions

Reference temperature range:.....15 °C ... 35 °C
Reference humidity range:35 % ... 65 % RH

Operation conditions

Working temperature range:0 °C ... +40 °C
Maximum relative humidity:85 % RH (0 °C ... 40 °C), non-condensing

Storage conditions

Temperature range:-10 °C ... +60 °C
Maximum relative humidity:90 % RH (-10 °C ... +40 °C)
.....80 % RH (40 °C ... 60 °C)











Accuracies apply for 1 year in reference conditions. Temperature coefficient outside these limits is 0.2 % of measured value per °C plus 1 digit, otherwise noted.

Fuses

2 x T 16 A / 250 V, 32 mm × 6.3 mm / 1500 A

Appendix A Structure objects in OmegaEE XD

Structure elements used in Memory Organizer are instrument's Profile dependent.

Symbol	Default name	Description
	Node	Node
	Project	Project
	Location	Location
	Client	Client
	Appliance	Appliance (basic description)
	Appliance FD	Appliance (full description)
	Medical device	Medical device (basic description)
	Medical device FD	Medical device (full description)
	Welding device	Welding device (basic description)
	Welding device FD	Welding device (full description)
	Element	Universal element

Appendix B Profile Notes

There are no specific profile notes for OmegaEE XD.

Appendix C Print labels and write / read RFID / NFC tags

The instrument supports different printers, label size forms and two tag formats (PAT and Generic); listed parameters setting is described in chapter 4.10 *Devices*. By setting the printer, label size forms and tag formats are limited.

Tag content can be presented as text only or arranged as text area and machine-readable code area – barcode or QR code – in addition.

The instrument supports RFID / NFC reader / writer device; tag type supported is NTAG216.

Please check with Metrel or distributor which printers and labels are supported in your OmegaEE XD instrument.

C.1 **PAT tag format**

It is intended for tagging of individual appliance with Auto Sequence® test data. To start printing, Auto Sequence® should be finished and saved or reopened from memory structure. When required, printing of two labels of the same test can be set.

Available tag data presented in text area are:

- ▶ Auto Sequence® short Test code
- ▶ Appliance ID
- ▶ Appliance name
- ▶ Test date
- ▶ Retest date
- ▶ Auto Sequence® test status
- ▶ User name (who currently performed test or who performed saved test, if printed from memory)

Available tag data presented in machine-readable area are:

- ▶ Auto Sequence® short Test code
- ▶ Appliance ID
- ▶ Appliance name
- ▶ Test date
- ▶ Retest period (from appliance description)
- ▶ Appliance location (from appliance description)
- ▶ Auto Sequence® test status
- ▶ User name (who currently performed test or who performed saved test, if printed from memory)
- ▶ Auto Sequence® measurements results

Actual tag content depends on label type selection, when printing. Content of 1st and 2nd label is also adopted, when 2-label printing is selected.

Following tables describe tag content arrangement and its data for supported form sizes and chosen label type.

<i>Label type</i>	<i>Form size W x H (mm)</i>	<i>Tag content arrangement</i>	<i>Data 1st label</i>	<i>Data 2nd label</i>
Classic	50 x 25.5	Barcode	Test code, appliance ID	Appliance ID
		Text	Test code, appliance ID, test or retest date, status, user	Appliance ID, test or retest date, status, user
QR		QR	Test code, appliance ID, appliance name, test date, retest period, location, user, status, measurement results.	Appliance ID, appliance name, test date, retest period, location, user, status
		Text	Test code, appliance ID, appliance name, test or retest date, status, user	Appliance ID, appliance name, test or retest date, status, user
Simple		Text	Appliance ID, appliance name, status, test or retest date, user	

<i>Label type</i>	<i>Form size W x H (mm)</i>	<i>Tag content arrangement</i>	<i>Data 1st label</i>	<i>Data 2nd label</i>
Classic L	43 x 99	Barcode	Test code, appliance ID	Appliance ID
		Text	Test code, appliance ID, test and retest date, status, user	Appliance ID, test and retest date, status, user
QR L		QR	Test code, appliance ID, appliance name, test date, retest period, location, user, status, measurement results.	Appliance ID, appliance name, test date, retest period, location, user, status
		Text	Test code, appliance ID, appliance name, test and retest date, status, user	Appliance ID, appliance name, test and retest date, status, user

<i>Label type</i>	<i>Size W x H (mm)</i>	<i>Tag content arrangement</i>	<i>Data 1st label</i>	<i>Data 2nd label</i>
Classic L (inverted)	100 x 50	Barcode	Test code, appliance ID	Appliance ID
		Text	Test code, appliance ID, test and retest date, status, user	Appliance ID, test and retest date, status, user
QR L (inverted)		QR	Test code, appliance ID, appliance name, test date, retest period, location, user, status, measurement results.	Appliance ID, appliance name, test date, retest period, location, user, status

		Text	Test code, appliance ID, appliance name, test and retest date, status, user	Appliance ID, appliance name, test and retest date, status, user
--	--	------	---	--

Notes:

- › 2nd label is intended to mark supply cords.
- › Data not available will not be printed on the label.
- › Test or Retest date: is set in the General Settings => Devices => Writing devices menu.
- › If Auto Sequence® was modified, its short code is marked with asterisk (*).

Following table describes data content written on RFID / NFC tag.

RFID / NFC tag type	Data
NTAG216	Test code, appliance ID, appliance name, test date, retest period, location, user, status, measurement results.

C.2 Generic tag format

It is intended for tagging structure objects (element, appliance, equipment), which could be tested and their location under parent structure object is important. Label printing can be started from selected structure object (element, appliance, equipment), even if no Auto Sequence® is associated with it, or from finished Auto Sequence® saved under it.

Tag data presented in text area are:

- › Parent structure object ID (name) (← Object_name)
- › Auto Sequence® short test code (if printing from Auto Sequence®; if printing from object field is omitted)
- › Object ID (name)
- › Test date (|→ DD.MM.YYYY) or Retest date (→| DD.MM.YYYY), which one is selected in General Settings => Devices => Writing devices menu
- › Status (printing from object: overall status of all tests appended to the object or sub-structure objects; printing from Auto Sequence®: its status)
- › User name (Printing from Auto Sequence: user who performed test; printing from object: current signed-in user)

Tag data presented in machine-readable area are:

- › Parent structure object ID (name)
- › Auto Sequence® short test code (if printing from Auto Sequence®; if printing from object field is omitted)
- › Object ID (name)
- › Test date
- › Retest period (from appliance description)
- › Auto Sequence® status (field is omitted, if not printing from Auto Sequence®)
- › Object status (overall status of all tests appended to the object or sub-structure objects)
- › User name (Printing from Auto Sequence®: user who performed test; printing from object: current signed-in user)

Following table describes tag content arrangement and its data for supported label form size.

<i>Form size W x H (mm)</i>	<i>Tag content arrangement</i>	<i>Data</i>
50 x 25.5	Text	Parent object name, Test code, Object ID, test or retest date, status, user
	QR	Parent object name, Test code, Object ID, test date, retest period, Auto Sequence® status, Object status, user.

Notes:

- Data not available will not be printed on the label.
- Object without appended Auto Sequence® test has no status!
- If Auto Sequence® was modified, its short code is marked with asterisk (*).
- Object status depends on all measurements (Auto Sequences® or Single tests) appended to the object or sub-structure objects, see chapter *Measurement status indication under the Structure object* for details.

Following table describes data content written on RFID / NFC tag.

RFID / NFC tag type	Data
NTAG216	Parent object name, Test code, Object ID, test date, retest period, Auto Sequence® status, Object status, user.

Appendix D Default list of Auto Sequences®

Default list of Auto Sequences® for OmegaEE XD instrument is available on Metrel home page:
<https://www.metrel.si>

Appendix E Programming of Auto Sequences® on Metrel ES Manager

The Auto Sequence® editor is a part of the Metrel ES Manager software. In Auto Sequence® editor Auto Sequence® can be pre-programmed and organized in groups, before uploaded to the instrument.

E.1 Auto Sequence® Editor workspace

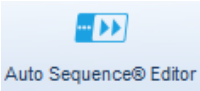
To enter Auto Sequence® Editor's workspace, select  in Home Tab of Metrel ES Manager PC SW. Auto Sequence® Editor workspace is divided in four main areas. On the left side **1**, structure of selected group of Auto Sequence® is displayed. In the middle part of the workspace **2**, the elements of the selected Auto Sequence® are shown. On the right side, list of available Single tests **3** and list of Flow commands **4** are shown. Single test area contains three tabs, Measurements, Inspections and Custom Inspections tab. Custom Inspections and their tasks are programmed by user.

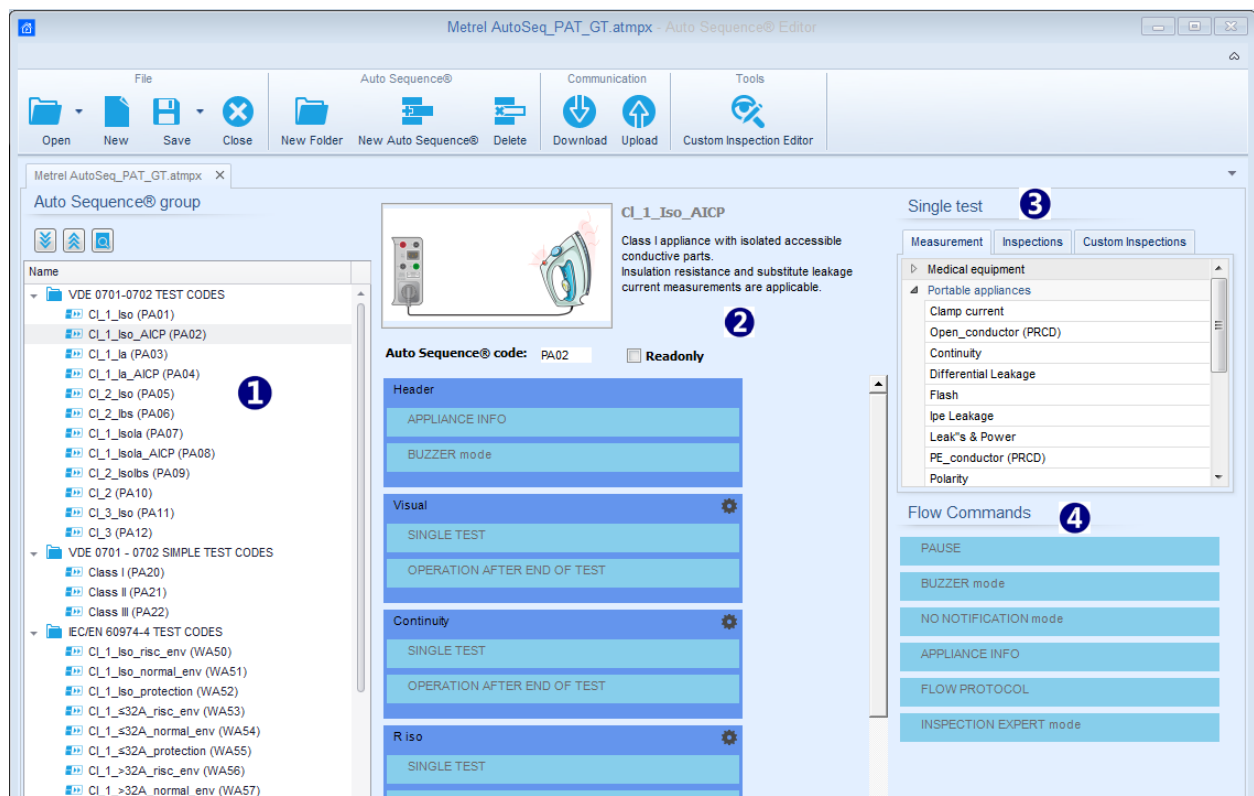

Figure E.1: Auto Sequence® Editor workspace

An Auto Sequence® **2** begins with Name, Description and Image, followed by the first step (Header), one or more measuring steps and ends with the last step (Result). By inserting

appropriate Single tests (measurements, inspections and custom inspections) **3** and Flow commands **4** and setting their parameters, arbitrary Auto Sequences® can be created.



Figure E.2: Example of an Auto Sequence® header

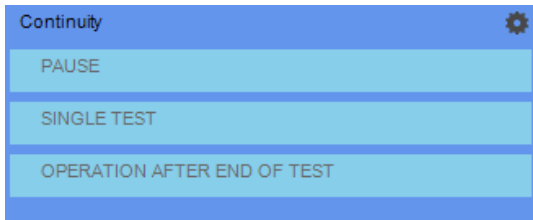

Figure E.3: Example of a measurement step



Figure E.4: Example of an Auto Sequence® result

E.2 Managing groups of Auto Sequences®

The Auto Sequences® can be divided into different user defined groups of Auto Sequences®. Each group of Auto Sequences® is stored in a file. More files can be opened simultaneously in Auto Sequence® editor.

Within Group of Auto Sequences®, tree structure can be organized, with folders / subfolders containing Auto Sequences®. The tree structure of currently active Group of Auto Sequences® is displayed on the left side of the Auto Sequence® editor workspace, see *Figure E.5*.

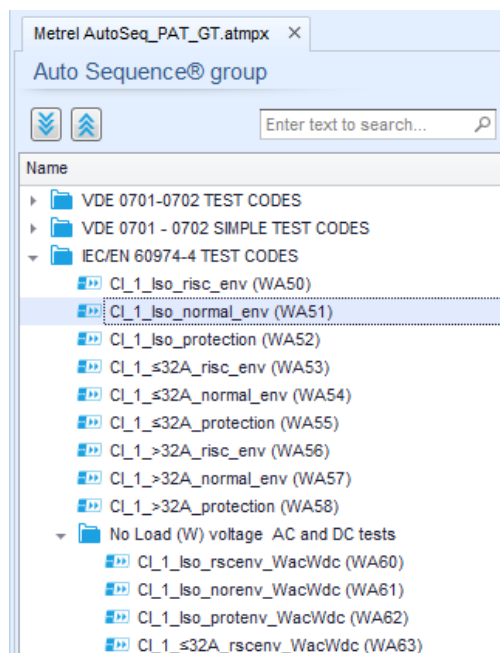









Figure E.5: Group of Auto Sequences® tree organization

Operation options on Group of Auto Sequences® are available from menu bar at the top of Auto Sequence® Editor workspace.



File operation options:

	Opens a file (Group of Auto Sequences®).
	Creates a new file (Group of Auto Sequences®).
	Saves / Saves as the opened Group of Auto Sequences® to a file.
	Closes the file (Group of Auto Sequences®).

Group of Auto Sequences® view options:



	Expand all folders / subfolders / Auto Sequences®.
	Collapse all folders / subfolders / Auto Sequences®.
	Search by name within Auto Sequence® group. See <i>Appendix E.2.2 Search within selected Auto Sequence® group</i> for details.

Group of Auto Sequences® operation options (also available by right clicking on Folder or Auto Sequence®):



	Adds a new folder / subfolder to the group
	Adds a new Auto Sequence® to the group.
	Deletes: <ul style="list-style-type: none"> - the selected Auto Sequence® - the selected folder with all subfolders and Auto Sequences®

Right click on the selected Auto Sequence® or Folder opens menu with additional possibilities:

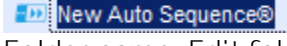

	Auto Sequence®: Edit Name, Description and Image (see <i>Figure E.6</i>). Folder: Edit folder name
---	--

	Auto Sequence®: Copy to clipboard Folder: Copy to clipboard including subfolders and Auto Sequences®
	Auto Sequence®: Paste it to selected location Folder: Paste it to selected location
	Auto Sequence®: Creates shortcut to selected Auto Sequence®

Double click on the object name allows it name edit:

DOUBLE CLICK	Auto Sequence® name: Edit Auto Sequence® name  Folder name: Edit folder name 
--------------	--

Drag and drop of the selected Auto Sequence® or Folder / Subfolder moves it to a new location:

DRAG & DROP	<p>“Drag and drop” functionality is equivalent to “cut” and “paste” in a single move.</p> <p> move to folder</p> <p> insert</p>
-------------	---



E.2.1 Auto Sequence® Name, Description and Image editing

When EDIT function is selected on Auto Sequence®, menu for editing presented on *Figure E.6* appear on the screen. Editing options are:

Name: Edit or change the name of Auto Sequence®.

Description: Any text for additional description of Auto Sequence® can be entered.

Image: Image presenting Auto sequence® measuring arrangement can be entered or deleted.

	Enters menu for browsing to Image location.
	Deletes the Image from Auto Sequence®.

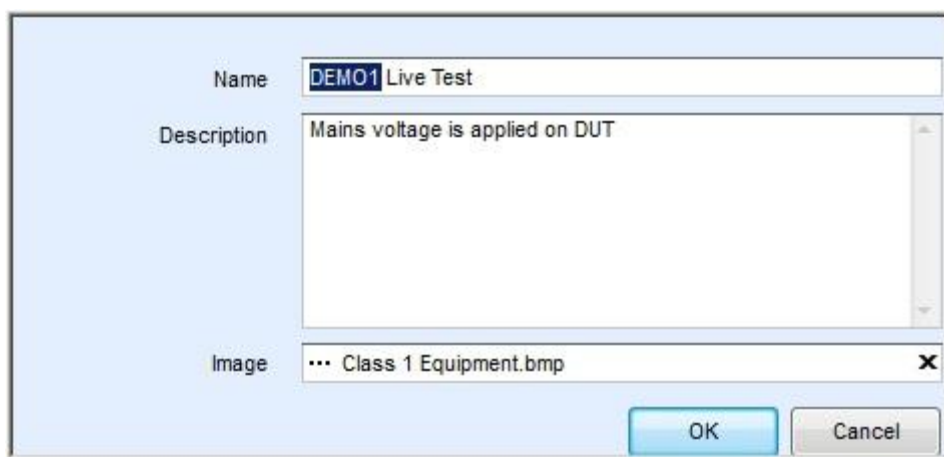





Figure E.6: Editing the Auto Sequence® Name, Description and Image

E.2.2 Search within selected Auto Sequence® group

By entering the text into search box and click on the search  icon, found results are highlighted with yellow background and first found result (Folder or Auto Sequence®) is focused.

Click on the Search icon  again focus next search result. Search functionality is implemented in Folders, Subfolders and Auto Sequences® of selected Auto Sequence® Group. Search text can be cleared by selecting the Clear  button.

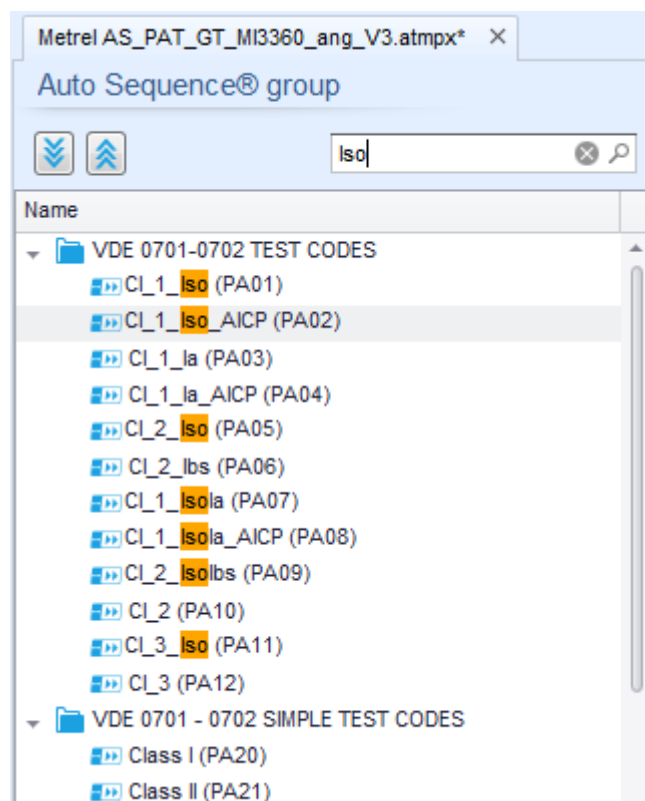

Figure E.7: Example of Search result within Auto Sequence® group

E.3 Elements of an Auto Sequence®

E.3.1 Auto Sequence® steps

Auto Sequence® code

A code can be added to custom made Auto Sequences®.

Instructed person use

This checkbox must be checked, to allow the use of the Auto Sequence® by instructed persons. See chapter *User Accounts* and *Appendix G - User permissions* for more information.

Header

The Header step is empty by default.

Flow commands can be added to the Header step.

Measurement step

The Measurement step contains a Single test and the Operation after end of test flow command by default. Other Flow commands can also be added to the Measurement step.

Result

The Result step contains the Result screen flow command by default. Other Flow commands can also be added to the Result step.

E.3.2 Single tests

Single tests are the same as in Metrel ES Manager Measurement menu.

Limits and parameters of the measurements can be set. Results and sub-results can't be set.

E.3.3 Flow commands

Flow commands are used to control the flow of measurements. Refer to chapter *E.5 Description of flow commands* for more information.



E.3.4 Number of measurement steps

Often the same measurement step has to be performed on multiple points on the device under test. It is possible to set how many times a Measurement step will be repeated. All carried out individual Single test results are stored in the Auto Sequence® result as if they were programmed as independent measuring steps.

E.4 Creating / modifying an Auto Sequence®

If creating a new Auto Sequence® from scratch, the first step (Header) and the last step (Result) are offered by default. Measurement steps are inserted by the user.

Options:

Adding a measurement step	By double clicking on a Single test a new measurement step will appear as the last of measurement steps. It can also be dragged and dropped on the appropriate position in the Auto Sequence®.
Adding flow commands	Selected flow command can be dragged from the list of Flow commands and dropped on the appropriate place in any Auto Sequence® step.
Changing position of flow command within measurement step	By a click on an element and use of   keys.
Viewing / changing parameters of flow commands or single tests.	By a double click on the element.
Setting number of measurement step repetitions	By setting a number in the  field.

Right click on the selected measurement step / flow command:

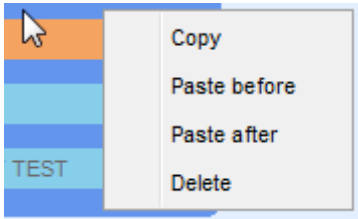
	<p>Copy - Paste before A measurement step / flow command can be copied and pasted above selected location on the same or on another Auto Sequence®.</p> <p>Copy - Paste after A measurement step / flow command can be copied and pasted under selected location on the same or on another Auto Sequence®.</p> <p>Delete Deletes the selected measurement step / flow command.</p>
---	---

E.5 Description of flow commands

Double click on inserted Flow Command opens menu window, where text or picture can be entered, external commands can be activated and parameters can be set.

Flow commands Operation after end of test and Results screen are entered by default, others are user selectable from Flow Commands menu.

Pause

A Pause command with text message or picture can be inserted anywhere in the measuring steps. Warning icon can be set alone or added to text message. Arbitrary text message can be entered in prepared field Text of menu window.

Parameters:

Pause type	Show text and/or warning (<input checked="" type="checkbox"/> check to show warning icon) Show picture ( browse for image path)
Duration	Number in seconds, infinite (no entry)

Buzzer mode

Passed or failed measurement is indicated with beeps.

- ▶ Pass - double beep after the test
- ▶ Fail - long beep after the test

Beep happens right after single test measurement.

Parameters:

State	On - enables Buzzer mode Off - disables Buzzer mode
-------	--

No notifications mode

Instrument skips pre-test warnings (see chapter 4.5 *Symbols and messages* for more information).

Parameters:

State	On – enables No notifications mode Off – disables No notifications mode
-------	--

Appliance info

Instrument enables to automatically select the appliance type and add the Appliance ID, Appliance name and Retest period to the Auto Sequence®.

Parameters:

Repeat Setting	Repeat:	The same Appliance ID will be offered each time if the same Auto Sequence® is carried out successively in a loop.
	Increment:	A four-digit number will be added to the Appliance ID and incremented each time if the same Auto Sequence® is carried out successively in a loop.
Appliance type	Selects the type of the appliance (Appliance, Appliance_FD, Medical Equip., Medical Equip. FD, Welding Equip., Welding Equip. FD)	
Default Appliance ID	Enter default Appliance ID	
Appliance name	Enter Appliance name. Options: <input checked="" type="checkbox"/> Editable – allows Appliance name to be modified while running Auto Sequence®. Menu with a list of Appliance names and possibility to enter custom Appliance name is offered within the test. <input type="checkbox"/> Not editable – Default Appliance name is used. Appliance name cannot be modified while running Auto Sequence®.	
Retest period	Retest period in months. Options: <input checked="" type="checkbox"/> Editable – allows Retest period to be modified while running Auto Sequence®. Numeric keypad for entering custom Retest period is offered within the test. <input type="checkbox"/> Not editable – Default Retest period is used. Retest period cannot be modified while running Auto Sequence®.	

Note

- This flow command is active only if Auto Sequence® is started from the Auto Sequence® Main menu.

Inspection Expert mode

If Inspection Expert mode flow command is set, the Visual inspection screen and Functional inspection screen within Auto Sequence® are displayed for 1 second and an overall PASS is automatically applied at the end of test. In between, the automatic procedure can be stopped and statuses can be applied manually.

Inspection Expert mode is disabled by default.

Parameters:

State	On – enables automatic settings of tickers in Visual and Functional tests. Off – disables automatic settings of tickers in Visual and Functional tests.
-------	--

Operation after end of test

This flow command controls the proceeding of the Auto Sequence® in regard to the measurement results.

Parameters

Operation after end of test - pass - fail - no status	The operation can be individually set for the case the measurement passed, failed or ended without a status.	
	Manual:	The test sequence stops and waits for appropriate command (RUN key, external command..) to proceed.
	Auto:	The test sequence automatically proceeds.

Result screen

This flow commands control the proceeding after the Auto Sequence® has ended.

Parameters

<input checked="" type="checkbox"/> Auto Save	Auto Sequence® results are stored in the momentary workspace. A new Node with the date and time will be created. Under the Node Auto Sequence® results or (if Appliance info flow command is set) a new appliance and Auto Sequence® results will be stored. Up to 100 Auto Sequence® results or appliances can be automatically stored under the same node. If more results / appliances are available, they are split to multiple nodes. Local Save Flow setting is disabled by default. Note <ul style="list-style-type: none"> • This flow command is active only if Auto Sequence® is started from the Auto Sequence® Main menu (not from the Memory organizer).
<input checked="" type="checkbox"/> Auto Print	Auto Sequence® results are automatically printed. Print label menu will not be displayed. All printer and tag settings from Devices menu applies. Note <ul style="list-style-type: none"> • This flow command is active only if Auto Sequence® is started from the Auto Sequence® Main menu (not from the Memory organizer).

E.6 Custom Inspections programming

Arbitrary set of tasks dedicated to specific user defined Inspections can be programmed with application of Custom Inspection Editor Tool, accessible from Auto Sequence® Editor workspace. Custom Inspections are stored in dedicated file *.indf with user defined name. For application of Custom Inspections as a single test within Auto Sequence® group, appropriate file containing specific Custom Inspection should be opened first.

E.6.1 Creating and editing Custom Inspections

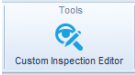
Custom Inspection Editor workspace is entered by selecting  icon from Auto Sequences® main menu. It is divided in two main areas, as presented on *Figure E.8*:

- 1 Custom Inspection Name and Scope of inspection (Visual or Functional)
- 2 Name of Custom Inspection Item tasks and Type of Item Pass / Fail checkbox marking

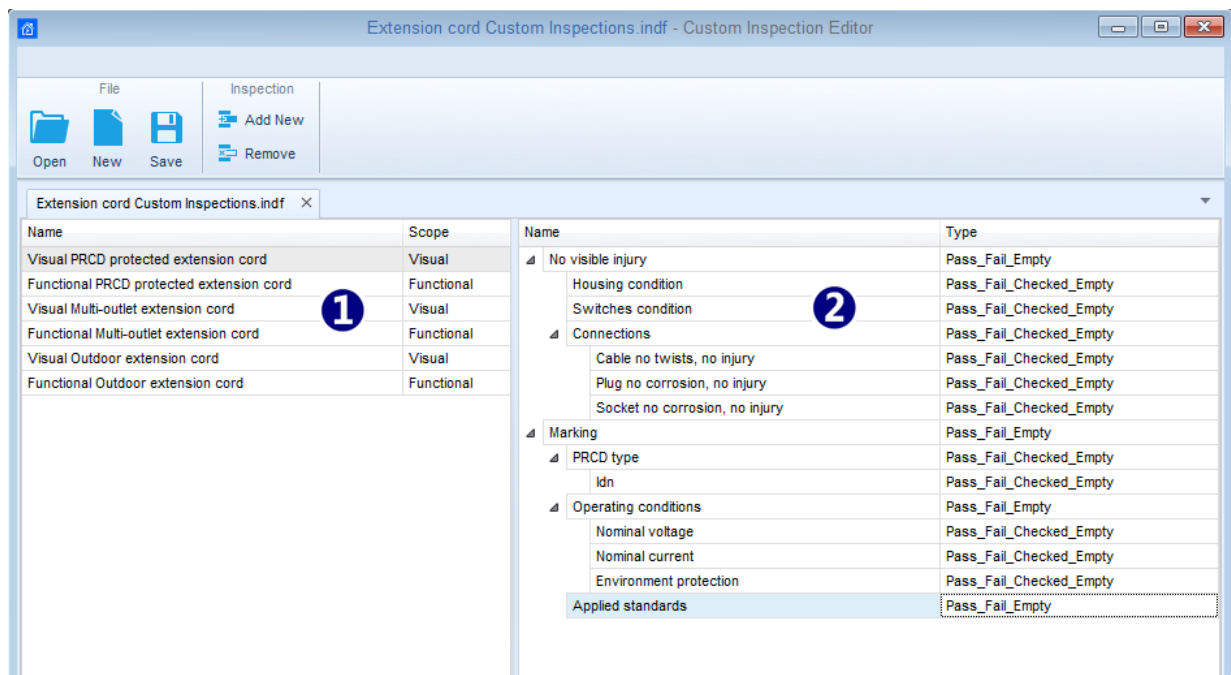

Figure E.8: Custom Inspection Editor workspace

Custom Inspection Editor Main menu options:



Opens existing Custom Inspection Data file.
By selecting, menu for browsing to location of *.indf file containing one or more Custom Inspections data appear on the screen. Selected file is opened in dedicated tab marked with file name.



Creates a new Custom Inspection Data file.
New tab with empty workspace is opened. Default name of the new tab is *Inspection Data File*; it could be renamed during Save procedure.



Saves / Saves as Custom Inspection Data file opened on active tab.
 Menu for browsing to the folder location and editing of file name is opened.
 Browse to the location, confirm overwriting, if file already exists or edit file name to save it as a new Custom Inspection Data file.



Add New Custom Inspection.
 New inspection with default name *Custom Inspection* and default scope *Visual* appear on the editor workspace. It contains one Item task with default name *Custom Inspection* and default Type *Pass_Fail_Checked_Empty*. Default Name and Type can be edited – changed.



Remove selected custom inspection.
 To select inspection, click to the inspection Name field. To remove it, select icon from editor main menu. Before removal, user is asked to confirm deletion.

Edit Name and Scope of Inspection

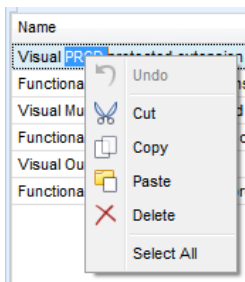

Inspection Name edit:
 Click to the Inspection Name field to start editing it.
 Drag cursor, with left mouse button pressed, to select letters and words. Position cursor and double-click to select word of the name.
 Actions could be performed with keyboard also.
 Press right mouse button to activate Edit menu and select appropriate action as presented on the left figure. Menu is case sensitive; options currently not available are greyed out.

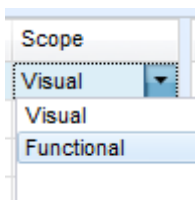

Inspection Scope edit:
 Click to Inspection Scope field to open selection menu presented on left figure. Options:
 Visual is intended for observation of test object
 Functional allows functional test of observed object

Edit Item task structure of Inspection

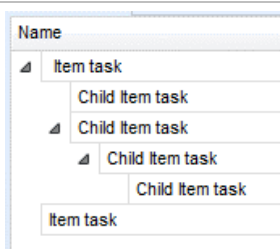

Item tasks of the selected Inspection are listed in Name column on the right side of Editor workspace.
 Each Item task can have Child Item tasks, Child Item can have its own Child Item tasks and so on.
 Arbitrary tree structure of Item tasks and subtasks can be built as presented on left figure.

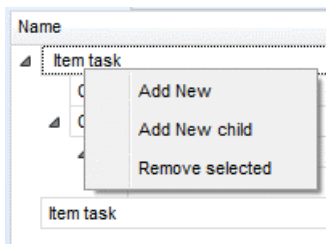

ADD New Item task procedure:
 Position cursor above Item task Name and apply right mouse click to select Item task and open menu with options:
 Add New: new Item task is added on the top tree level
 Add New Child: new child Item task is added under selected Item
 Remove selected: delete selected Item task with all subtasks

Default Name of New Item task is *Custom Inspection*, default Type *Pass_Fail_Checked_Empty* and both can be edited – changed.

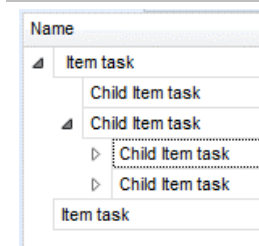

Item tasks containing Child Item tasks are marked with triangle in front of their Name.

Click on triangle mark:

- ◀ collapse Item task tree structure
- ▶ expands Item task tree structure

Edit Name and Type of Item task

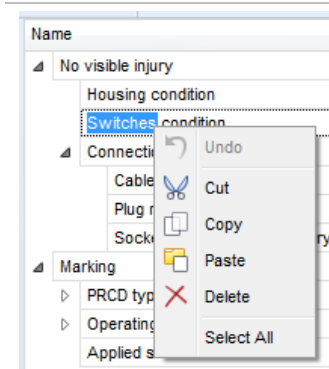

Edit Name of Item task:

Click to the Item task Name field to start editing it.

Drag cursor, with left mouse button pressed, to select letters and words. Position cursor and double-click to select word of the name. Actions could be performed with keyboard also.

Press right mouse button to activate Edit menu and select appropriate action as presented on the left figure. Menu is case sensitive; options currently not available are greyed out.

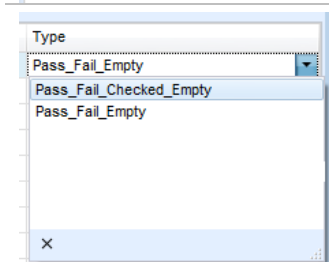

Edit Type of Item task:

Click to Item Type field to open selection menu presented on left figure. Selectable checkbox status assignment options are:

Pass_Fail_Checked_Empty: Pass, Fail, Checked, Empty (default)

Pass_Fail_Empty: Pass, Fail selection, Empty (default) value

E.6.2 Applying Custom Inspections

Custom inspections can be applied in Auto Sequences®. Direct assignment of Custom inspection to the Metrel ES manager structure objects is not possible.

After custom created Inspection Data file is opened, available inspections are listed in Custom Inspections tab of Single test area of Auto Sequence® Editor, see chapter *E.1 Auto Sequence® Editor workspace* for details.

Custom Inspection is added to Auto sequence as a Single test, see chapter *E.4 Creating / modifying an Auto Sequence®* for details.

Opening / changing Inspection Data File

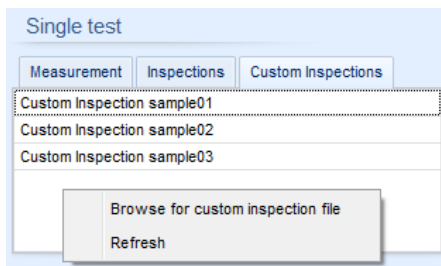

Position cursor within Custom inspections List area and apply mouse right click to open Option menu:

Refresh: Refresh content of already opened Inspection Data file.

Browse for custom Inspection file:

Menu for browsing to folder location of new Inspection Data file is opened.

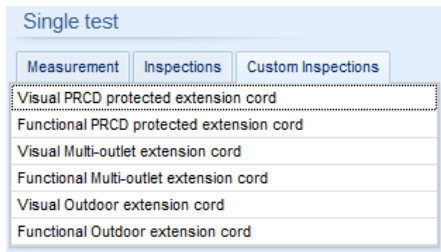

After confirmation of selection, new Inspection Data file is opened and list of available Custom Inspections is changed.

Note:

- If Metrel ES Manager Work scope is changed, opened Inspection Data file remains active and available Custom Inspections remains the same.

Appendix F Testing in IT or CT supply systems

When testing appliances in IT or CT supply system, some test functions in the instrument are omitted due to safety reasons. Following is a list of applicable test functions.

Test function	Supply system	
	CT	IT
<i>Continuity</i>	✓	✓
<i>Protective earth resistance</i>	✓	✓
<i>Flash test</i>	✓	✓
<i>Insulation resistance (Riso, Riso-S)</i>	✓	✓
<i>Sub-leakage ISUB (Extended)</i>	✓	✓
<i>Differential Leakage (Extended)</i>	✓	✓
<i>I_{pe} Leakage (Extended)</i>	✓	✓
<i>Touch Leakage (Extended)</i>	✓	✓
<i>Power</i>	✓	✓
<i>Leak's & Power (Extended)</i>	✓	✓
<i>PRCD test</i>	none	none
<i>PE conductor (PRCD)</i>	none	none
<i>RCD test</i>	✓	✓
<i>Open conductor (PRCD)</i>	none	none
<i>PRCD PE probe test</i>	none	none
<i>Polarity - Normal</i>	✓	✓
<i>Polarity - Active</i>	none	none
<i>Clamp current</i>	✓	✓
<i>Insulation resistance - Riso (medical equipment)</i>	✓	✓
<i>Equipment Leakage (Extended)</i>	✓	✓
<i>Applied Part Leakage (Extended)</i>	✓	✓
<i>Touch Current (medical eq., Extended)</i>	✓	✓
<i>I_{to}+I_{fi} (Extended)</i>	✓	✓
<i>I_{pe}+I_{fi} (Extended)</i>	✓	✓
<i>Patient leakage (medical eq., Extended)</i>	✓	✓
<i>SELV/PELV Voltage</i>	✓	✓
<i>EVSE Diagnostic Test (A 1632)</i>	✓	✓
<i>EV-RCD</i>	none	none
<i>PE conductor (EV RCD)</i>	none	none
<i>Functional test</i>	✓	✓

Appendix G User permissions

Note

- Appendix H describe permissions for all OmegaEE XD instruments. If measurement / function setting is not supported by the instrument the information is irrelevant.

G.1 Standard

User can use all functions of the instrument, without limitations.

G.2 Instructed

Works with the instrument is restricted according to description below.

Auto Sequences®

Auto Sequence® can be used:

- if the 'Instructed person use' checkbox is checked. This checkbox can be set in *Metrel ES Manager*, in *Auto Sequence® editor*.

In general, changing of measuring parameters and limits on included single tests are not possible. Exceptions are:

Measurement	Parameters
All	Duration
All	Comment 1
All	Comment 2
RCD, PRCD, EV-RCD, PE conductor(PRCD)	IΔN
RCD, PRCD, PE_conductor(PRCD)	RCD type
PRCD, PRCD PE probe, Open_conductor(PRCD), PE_conductor(PRCD)	Design
I _{to} +I _{fi} , I _{pe} +I _{fi} measurements	U _{inp} max
Differential leakage, Touch leakage, I _{pe} leakage	Adapter

Measurements	Limits
Leaks&Power	H limit, L limit
Power	H limit, L limit
Continuity, Protective earth resistance, PE_conductor(PRCD), PE_conductor(EV RCD)	H limit ¹⁾

¹⁾ Configurable with Auto Sequence® configurator (Limit calculator)

Single tests

Single tests cannot be carried out.

Settings - Limitations

Test mode	Limited to [standard]
Auto Sequence® flow	Limited to [ends if fail]
Result type	Limited to [worst]

Profiles

The Profiles menu is not accessible.

Initial settings

Initial settings cannot be carried out.

Appendix H OmegaEE XD models and available measuring functions

Measuring function	MI 3365	MI 3365 25A	MI 3365 M	MI 3365 F
Visual inspections	•	•	•	•
Fuse test	•	•	•	•
Continuity // Protective earth resistance 200 mA	•	•	•	•
Continuity // Protective earth resistance 10 A, 25 A		•	•	•
Insulation Resistance (Riso, Riso-S),	•	•	•	•
Substitute Leakage Current, Substitute Leakage Current - S	•	•	•	•
Differential Leakage current	•	•	•	•
PE leakage current	•	•	•	•
Touch leakage current	•	•	•	•
Leakage current produced by a floating input (Itou + IFI)	•	•	•	•
Leakage current produced by a floating input (IPE + IFI)	•	•	•	•
Polarity / Active polarity test	•	•	•	•
Power (P, S, Q, PF, THDu, THDi, CosØ, I, U)	•	•	•	•
Leaks&Power	•	•	•	•
SELV/PELV Voltage	•	•	•	•
Functional test	•	•	•	•
PRCD, (2-pole, 3-pole, K/Di (varistor), S (3-pole))	•	•	•	•
PRCD PE probe test, open conductor test, PE conductor test	•	•	•	•
RCD test, (type A, AC, B, B+, F)	•	•	•	•
Flash test, (1500 V, 3000 V)				•
Insulation resistance, IEC/EN 62353			•	
Touch leakage current, IEC/EN 62353, IEC 60601			•	
Equipment leakage (direct, differential, alternative) IEC/EN 62353			•	
Applied part leakage (direct, alternative), IEC/EN 62353			•	
Patient leakage (IpME), IEC/EN 62353, IEC 60601			•	
Insulation resistance (optional A 1422), IEC/EN 60974-4	•	•	•	•
Welding circuit leakage (optional A 1422), IEC/EN 60974-4	•	•	•	•
Protective conductor current (optional A 1422), IEC/EN 60974-4	•	•	•	•
No-load voltage (optional A 1422), IEC/EN 60974-4	•	•	•	•
Clamp current (with optional A 1579)	•	•	•	•
EV-RCD (with optional A 1632)	•	•	•	•
PE_conductor (EV RCD) (with optional A 1632)	•	•	•	•
EVSE Diagnostic test (with optional A 1632)	•	•	•	•

Measuring function	MI 3365	MI 3365 25A	MI 3365 M	MI 3365 F
Continuity // Protective earth resistance 200 mA (with optional A 1830)	•	•	•	•
Continuity // Protective earth resistance 10 A, 25 A (with optional A 1830)		•	•	•
Insulation Resistance (Riso, Riso-S) (with optional A 1830)	•	•	•	•
Substitute Leakage Current, Substitute Leakage Current - S (with optional A 1830)	•	•	•	•
Differential Leakage current (with optional A 1830)	•	•	•	•
PE leakage current (with optional A 1830)	•	•	•	•
Touch leakage current (with optional A 1830)	•	•	•	•

Note

Measurements can only be performed in combination with optional accessories:

- IEC/EN 60974-4 measurements are supported with active 3-phase adapter A 1422
- Clamp current leakage measurements are supported with optional clamps A 1579
- Measurements supported with 3-phase Active Leakage Adapter A 1830